



MASTER LEDspot ExpertColor LV

MASTER LED MR16 ExpertColor 7.2-50W 940 36D

MASTER LEDspot LV ExpertColor creates a warm and comfortable ambience for hospitality venues, homes and restaurants. It creates such an ambience with superior lighting that has a customized spectrum, high CRI, and deep dimming feature. The result? A beautiful lighting experience. What's more, the innovative, trimless lens design will suit almost any interior decor with its clean and neat look. In addition, you can take advantage of the full ExpertColor family, which also includes LEDspot MV and LEDspot Par lamps.

Product data

General Information	
Cap-Base	GU5.3 [GU5.3]
EU RoHS compliant	Yes
Nominal Lifetime (Nom)	40000 h
Switching Cycle	50000X
Technical Type	7.2-50W
Light Technical	
Color Code	940 [CCT of 4000K]
Beam Angle (Nom)	36 °
Luminous Flux (Nom)	480 lm
Luminous Intensity (Nom)	1450 cd
Color Designation	Cool White (CW)
Correlated Color Temperature (Nom)	4000 K
Luminous Efficacy (rated) (Nom)	66.67 lm/W
Color Consistency	<3
Color Rendering Index (Nom)	97

LLMF At End Of Nominal Lifetime (Nom) 70 %	
Operating and Electrical	
Input Frequency	- Hz
Power (Nom)	7.2 W
Lamp Current (Nom)	800 mA
Wattage Equivalent	50 W
Starting Time (Nom)	0.5 s
Warm Up Time to 60% Light (Nom)	1 s
Power Factor (Nom)	0.7
Voltage (Nom)	12 V
Temperature	
T-Case Maximum (Nom)	92 °C
Controls and Dimming	
Dimmable	Yes

MASTER LEDspot ExpertColor LV

Approval and Application

Energy Efficiency Label (EEL)	Not applicable
Energy Saving Product	Yes
Suitable For Accent Lighting	Yes
Energy Consumption kWh/1000 h	- kWh

Product Data

Full product code	694793912163200
Order product name	MASTER LED MR16 ExpertColor 7.2-50W 940 36D

EAN/UPC - Product	6947939121632
Order code	929001242710
Numerator - Quantity Per Pack	1
Numerator - Packs per outer box	10
Material Nr. (12NC)	929001242710
Net Weight (Piece)	0.034 kg

Dimensional drawing

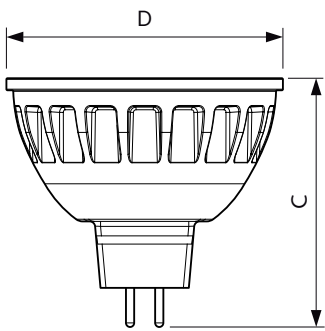

MR16 12V 7.2-50W 420lm 36D 4000K GU5.3 D

Product	D	C
MASTER LED MR16 ExpertColor 7.2-50W 940 36D	51 mm	46 mm

Photometric data

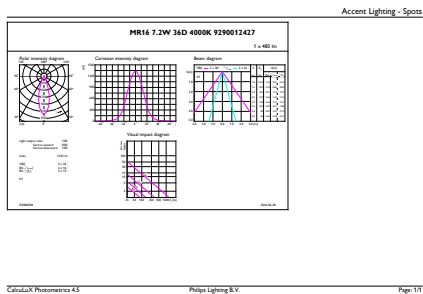

MAS LED ExpertColor 7.2-50W MR16 GU5.3 940 36D

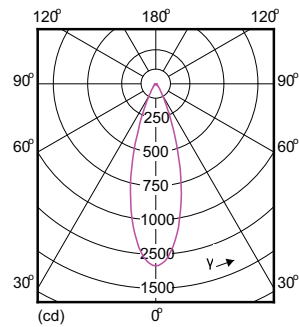

MAS LED ExpertColor 7.2-50W MR16 GU5.3 940 36D

MASTER LEDspot ExpertColor LV

Photometric data

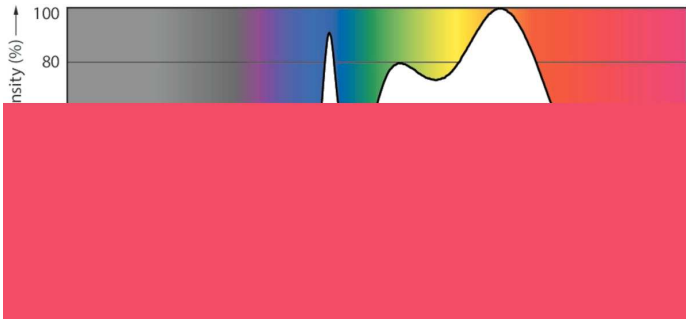

LEDspots MR16 7W 4000K

Lifetime

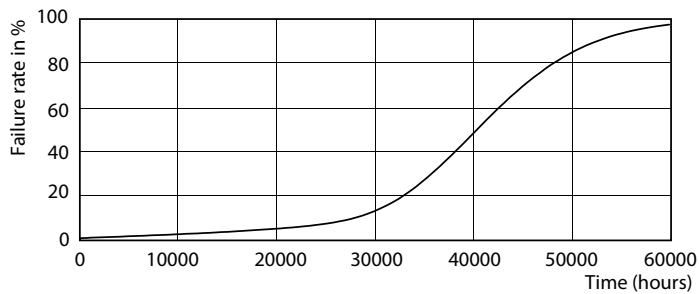

Master LEDspot ExpertColor LV 50W EZ10 927 10D

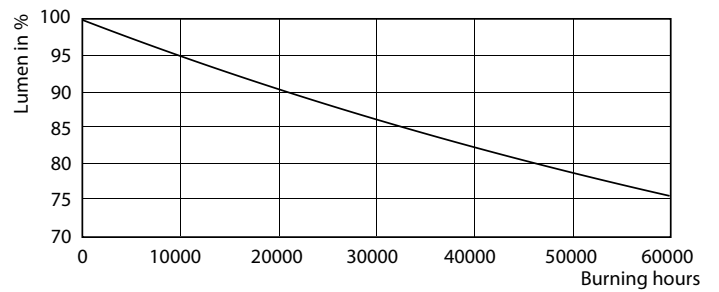

Master LEDspot ExpertColor LV 50W EZ10 927 10D

