



MASTER LEDtube EM/ Mains T8

Master LEDTube 1200 mm 18W 840 T8 I W

The Philips MASTER LEDtube integrates a LED light source into a traditional fluorescent form factor. Its unique design creates a perfectly uniform visual appearance which cannot be distinguished from traditional fluorescent. This product is the ideal solution for up lighting in general lighting applications.

Product data

General Information	
Cap base	G13 [Medium Bi-Pin Fluorescent]
EU RoHS compliant	Yes
Nominal lifetime (nom.)	40000 h
Switching cycle	50000X
Light Technical	
Colour Code	840 [CCT of 4,000 K]
Technical Beam Angle (Nom)	160 °
Lamp Luminous Flux 25°C EL (Nom)	2100 lm
Colour Temperature, horizontal (Nom)	4000 K
Colour consistency	<6
Colour Rendering Index, horiz (Nom)	82
LLMF at end of nominal lifetime (nom.)	70 %
Operating and Electrical	
Input frequency	50 to 60 Hz
Technical Lamp Power (Nom)	18 W
Starting time (nom.)	0.5 s
Warm-up time to 60% light (nom.)	instant full light s

Power factor (nom.)	0.92
Voltage (nom.)	100-240 V
Temperature	
T ambient (max.)	45 °C
T ambient (min.)	-20 °C
T storage (max.)	65 °C
T storage (min.)	-40 °C
T-Case maximum (nom.)	70 °C
Controls and Dimming	
Dimmable	no
Mechanical and Housing	
Product length	1200 mm
Approval and Application	
Energy efficiency label (EEL)	A+
Energy-saving product	Yes
Suitable for accent lighting	No

MASTER LEDtube EM/Mains T8

Approval marks	CE marking RoHS compliance KEMA Keur certificate
Energy Consumption kWh/1000 h	18 kWh
Product Data	
Full product code	871869652404600
Order product name	Master LEDTube 1200 mm 18W 840 T8 I W
EAN/UPC – product	8718696524046

Order code	929001187712
Numerator – quantity per pack	1
Numerator – packs per outer box	10
Material no. (12NC)	929001187712
Net weight (piece)	0.251 kg

Dimensional drawing

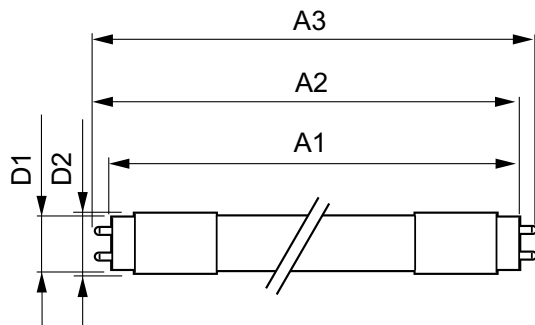

LEDtube 1200mm 18W/840 T8 I W

Product	D1	D2	A1	A2	A3
Master LEDTube 1200 mm 18W 840 T8 I W	25.6 mm	27.8 mm	1198.1 mm	1205.2 mm	1212.3 mm

Photometric data

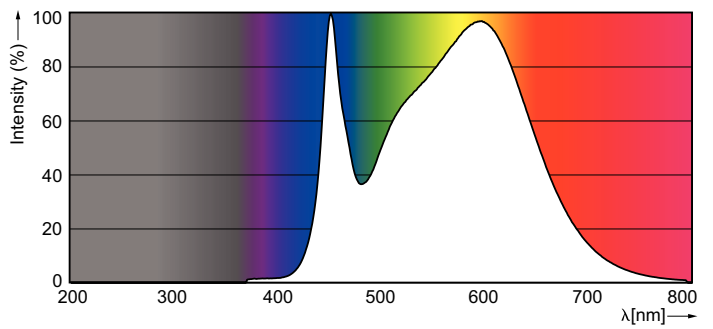
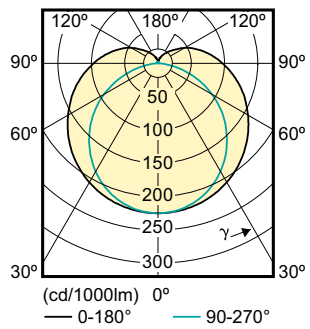

SDPO_MLEDGA_0068-Spectral Power distribution

MASTER LEDtube EM/Mains T8

Lifetime

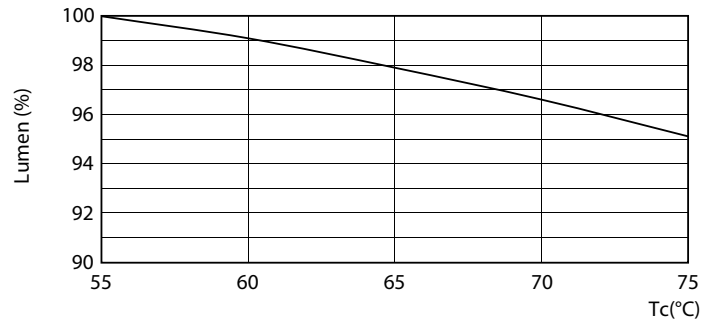
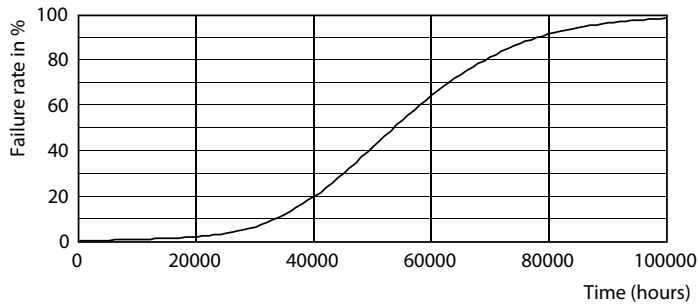

LEDTube 1200 mm 18W 840 T8 I W

LEDTube 1200 mm 18W 840 T8 I W LumenVsTc

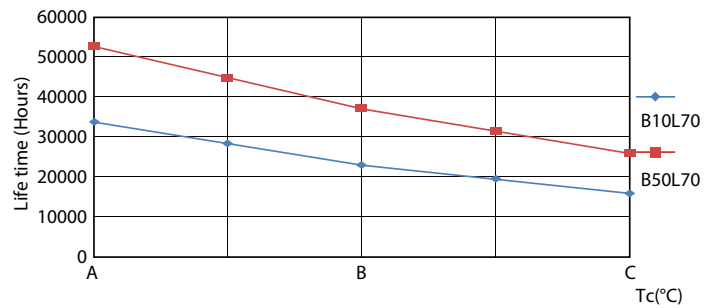
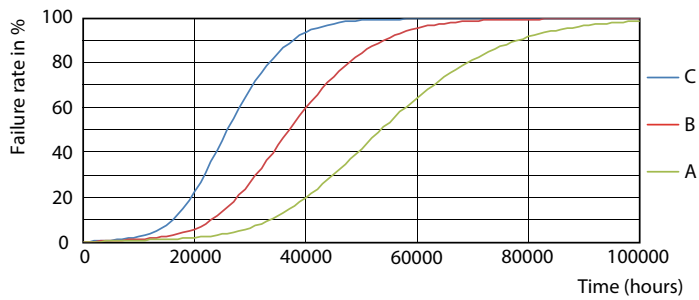

LEDTube 1200 mm 18W 840 T8 I W FailureRate

LEDTube 1200 mm 18W 840 T8 I W LifetimeVsTc

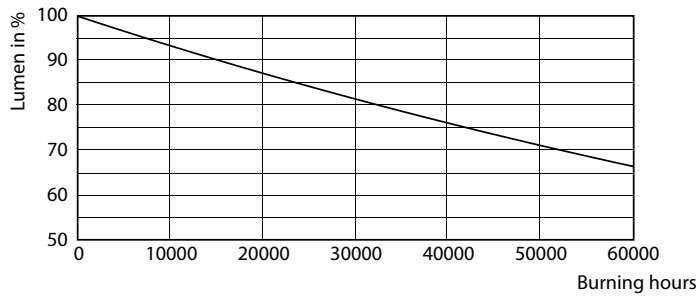

LEDTube 1200 mm 18W 840 T8 I W

MASTER LEDtube EM/Mains T8

