



MASTER LEDspot LV AR111

MAS LEDspotLV D 11-50W 930 AR111 40D

With its new perfect-fit design, the Master LEDspot LV AR111 now works with most of G53 luminaires as a true retrofit solution. The lamp creates a brilliant visual effect for retail and hospitality applications such as shops, showrooms and galleries. The high quality light brings out the true colors in merchandise and emphasizes its beauty. It also lasts long, with a strong lumen and color maintenance. The beautifully designed lamp offers a well-defined beam with a multitude of beam angles to suit various applications. Not only does it employ the Philips patented solution to ensure it is compatible with a broad selection of standard 12V halogen electronic transformers, it also delivers high beam intensity which equivalent to halogen AR111 spots of 50W, 75W or 100W.

Product data

General Information	
Cap-Base	G53 [G53]
EU RoHS compliant	Yes
Nominal Lifetime (Nom)	40000 h
Switching Cycle	50000X
Technical Type	11-50W
Light Technical	
Color Code	930 [CCT of 3000K]
Beam Angle (Nom)	40 °
Luminous Flux (Nom)	570 lm
Luminous Intensity (Nom)	1150 cd
Color Designation	White (WH)
Correlated Color Temperature (Nom)	3000 K
Luminous Efficacy (rated) (Nom)	51.82 lm/W

Color Consistency	<3
Color Rendering Index (Nom)	90
LLMF At End Of Nominal Lifetime (Nom)	70 %
Luminous Flux in 90° Cone (Rated)	570 lm
Operating and Electrical	
Input Frequency	- Hz
Power (Nom)	11 W
Lamp Current (Nom)	1300 mA
Wattage Equivalent	50 W
Starting Time (Nom)	0.5 s
Warm Up Time to 60% Light (Nom)	0.5 s
Power Factor (Nom)	0.7
Voltage (Nom)	12 V

MASTER LEDspot LV AR111

Temperature

T-Case Maximum (Nom)	70 °C
----------------------	-------

Controls and Dimming

Dimmable	Yes
----------	-----

Approval and Application

Energy Efficiency Label (EEL)	A
Suitable For Accent Lighting	Yes
Energy Consumption kWh/1000 h	13 kWh

Product Data

Full product code	871869651494800
Order product name	MAS LEDspotLV D 11-50W 930 AR111 40D
EAN/UPC - Product	8718696514948
Order code	929001170102
Numerator - Quantity Per Pack	1
Numerator - Packs per outer box	6
Material Nr. (12NC)	929001170102
Net Weight (Piece)	0.160 kg

Dimensional drawing

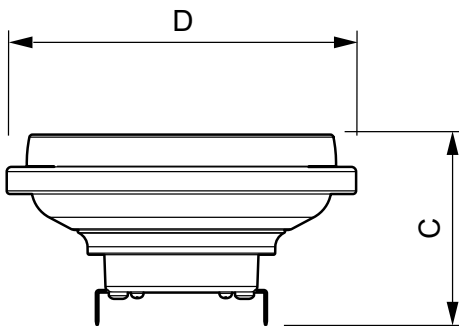

LED D 11-50W 930 AR111 40D

Product

MAS LEDspotLV D 11-50W 930 AR111 40D

Photometric data

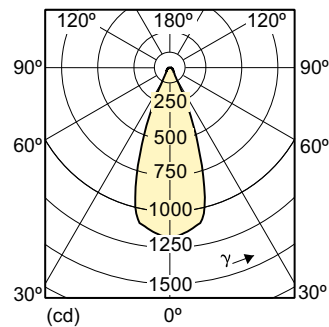
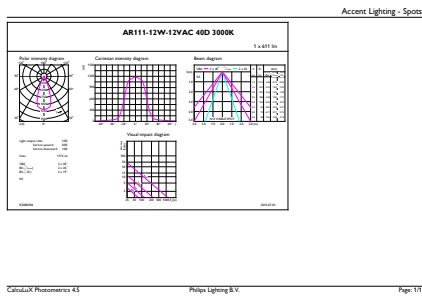

MASTER LEDspot LV AR111 50W G53 930 40D

MASTER LEDspot LV AR111

Photometric data

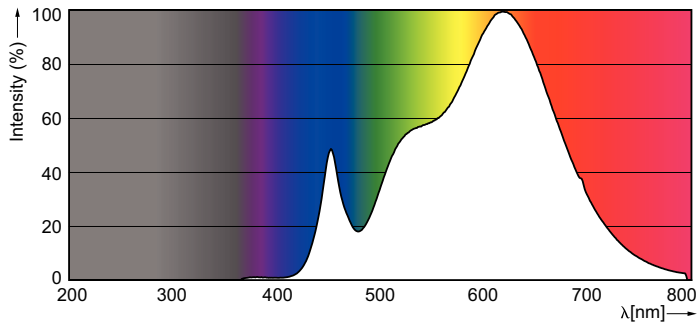

SDPO_LEDspotL_0026-Spectral Power distribution

Lifetime



MASTER LEDspotLV AR111 75W G53 940 40D



MASTER LEDspotLV AR111 75W G53 940 40D

