



Zadora LED

RS049B LED-MS-40-5W-4000-GU10 WH 50W

5 W - 4000 K - White

Zadora LED is a range of recessed adjustable downlights for MASTERLEDspot lamps. They come in ready-to-install KIT versions including the MASTERLEDspot MV lamp. MASTER LEDspot delivers huge energy savings and minimizes maintenance cost without compromising on brightness, enabling owners to achieve a return on their investment within one year. The adjustable version offers 30° orientation from the vertical. Both lamps deliver a flux equivalent to that of a 50 W halogen lamp. Zadora LED downlights are available in different color finishes. Maintenance is easy as the lamp can be accessed directly

Product data

General Information		Input Frequency	
Lamp power	5 W	Input Frequency	50 to 60 Hz
Light source color	840 neutral white	Power Factor (Min)	0.7
Light source replaceable	Yes	Controls and Dimming	
Gear	-	Dimmable	Yes
Driver/power unit/transformer	Power supply unit regulating	Mechanical and Housing	
Optic type	Beam angle 40°	Housing Material	Plastic
Luminaire light beam spread	40°	Reflector material	-
Connection	Screw connection block 3-pole	Optic material	Polymethyl methacrylate
Cable	-	Optical cover/lens material	Polycarbonate
Protection class IEC	Safety class II	Fixation material	Stainless steel
CE mark	CE mark	Optical cover/lens finish	Frosted
Warranty period	1 years	Overall length	145 mm
Constant light output	No	Overall width	145 mm
Operating and Electrical		Overall height	145 mm
Input Voltage	220 to 240 V	Overall diameter	85 mm

Zadora LED

Color	White
Dimensions (Height x Width x Depth)	145 x 145 x 145 mm (5.7 x 5.7 x 5.7 in)
Approval and Application	
Ingress protection code	IP20 [Finger-protected]
Mech. impact protection code	IK02 [0.2 J standard]
Initial Performance (IEC Compliant)	
Initial luminous flux (system flux)	380 lm
Luminous flux tolerance	+/-10%
Initial LED luminaire efficacy	78 lm/W
Init. Corr. Color Temperature	4000 K
Init. Color Rendering Index	80
Initial chromaticity	(0.38, 0.37) SDCM <5
Initial input power	5 W
Power consumption tolerance	+/-10%

Application Conditions

Ambient temperature range	-20 to +45 °C
---------------------------	---------------

Product Data

Full product code	871869607013099
Order product name	RS049B LED-MS-40-5W-4000-GU10 WH 50W
EAN/UPC - Product	8718696070130
Order code	912401483105
Numerator - Quantity Per Pack	1
Numerator - Packs per outer box	36
Material Nr. (12NC)	912401483105
Net Weight (Piece)	0.260 kg



Dimensional drawing

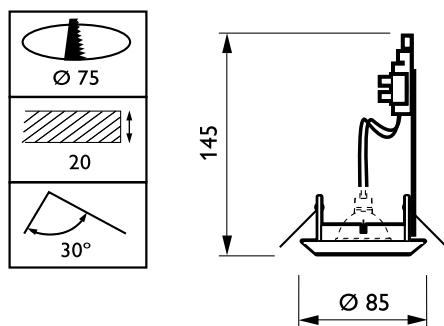

Zadora LED RS049B

