



LuxSpace Accent

RS741B LED27S/930 PSU-E MB WH

LuxSpace Accent Compact G3 - LED Module, system flux 2700 lm - 930 warm white - Power supply unit external - Medium beam - White

Retailers are increasingly having to contend with rising energy prices. At the same time, they need to retain the quality of light they are used to, flexibility in architectural integration, and the right light effects to catch the customer's eye. Last but not least, they need future-proof solutions that will enable them to implement differentiating concepts in their store. Delivering high-quality light, punch in the beam and outstanding luminous efficacy, LuxSpace Accent is the ideal energy-efficient solution for today's demanding retail environments, covering a wide variety of lighting applications, including CrispWhite and PremiumWhite for fashion stores and Food recipes for supermarkets.

Product data

General Information			
Number of light sources	1 pc	Connection	Push-in connector and pull relief
Lamp family code	LED27S [LED Module, system flux 2700 lm]	Cable	-
Beam angle of light source	120 °	Protection class IEC	Safety class II
Light source color	930 warm white	Glow-wire test	Temperature 650 °C, duration 5 s
Light source replaceable	No	Flammability mark	For mounting on normally flammable surfaces
Number of gear units	1 unit	CE mark	CE mark
Driver/power unit/transformer	Power supply unit external	ENEC mark	ENEC mark
Driver included	Yes	UL mark	-
Optic type	Medium beam	Warranty period	5 years
Optical cover/lens type	Clear glass	Remarks	*-Per Lighting Europe guidance paper "Evaluating performance of LED based luminaires - January 2018": statistically there
Luminaire light beam spread	24°		
Control interface	-		

LuxSpace Accent

	is no relevant difference in lumen maintenance between B50 and for example B10. Therefore, the median useful life (B50) value also represents the B10 value.
Constant light output	No
Number of products on MCB of 16 A type B	40
EU RoHS compliant	Yes
Service tag	Yes
Product family code	RS741B [LuxSpace Accent Compact G3]

Operating and Electrical

Input Voltage	220 to 240 V
Input Frequency	50 to 60 Hz
Initial CLO power consumption	- W
Average CLO power consumption	- W
Inrush current	5.3 A
Inrush time	0.7 ms
Power Factor (Min)	0.9

Controls and Dimming

Dimmable	No
----------	----

Mechanical and Housing

Housing Material	Aluminum
Reflector material	Polycarbonate aluminum coated
Optic material	Polycarbonate
Optical cover/lens material	Polycarbonate
Fixation material	-
Optical cover/lens finish	Clear
Overall height	126 mm
Overall diameter	130 mm
Color	White
Dimensions (Height x Width x Depth)	126 x NaN x NaN mm (5 x NaN x NaN in)

Approval and Application

Ingress protection code	IP20 [Finger-protected]
-------------------------	--------------------------

Mech. impact protection code	IK02 [0.2 J standard]
------------------------------	------------------------

Initial Performance (IEC Compliant)

Initial luminous flux (system flux)	2700 lm
Luminous flux tolerance	+/-10%
Initial LED luminaire efficacy	106 lm/W
Init. Corr. Color Temperature	3000 K
Init. Color Rendering Index	≥90
Initial chromaticity	(0.43, 0.40) SDCM <3
Initial input power	25.5 W
Power consumption tolerance	+/-10%

Over Time Performance (IEC Compliant)

Control gear failure rate at median useful life 50000 h	5 %
Lumen maintenance at median useful life* 50000 h	L80

Application Conditions

Ambient temperature range	+10 to +40 °C
Performance ambient temperature Tq	25 °C
Suitable for random switching	Yes

Product Data

Full product code	871869685141800
Order product name	RS741B LED27S/930 PSU-E MB WH
EAN/UPC - Product	8718696851418
Order code	910500457646
Numerator - Quantity Per Pack	1
Numerator - Packs per outer box	1
Material Nr. (12NC)	910500457646
Net Weight (Piece)	0.740 kg



Dimensional drawing

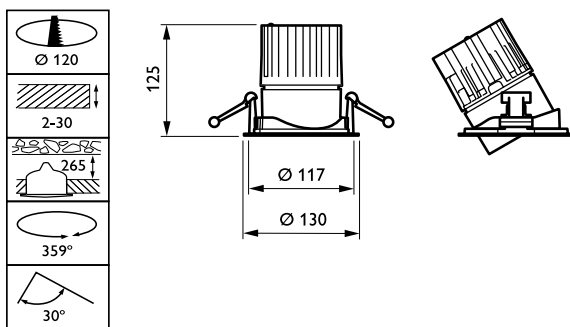

LuxSpace Accent RS730B-RS752B

LuxSpace Accent RS730B-RS752B

Photometric data

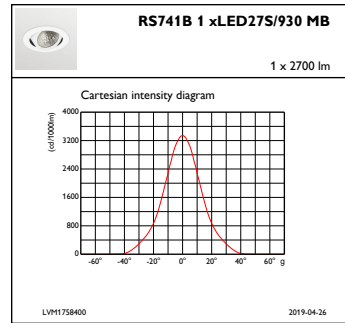
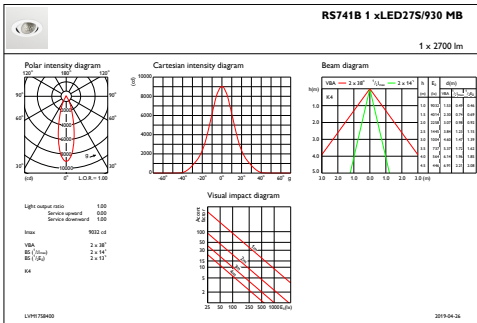

IFAS1_RS741B1xLED27S930MB

IFCC1_RS741B1xLED27S930MB

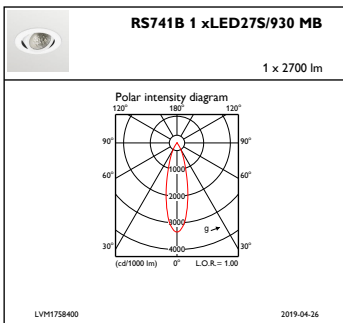

IFPC1_RS741B1xLED27S930MB

