



An energy-efficient solution

HF-Performer III for PL-T/C lamps

HF-Performer III PL-T/C is a sustainable, slim and high-frequency electronic ballast for PL-T and PL-C fluorescent lamps. It is ideal for applications where high energy efficiency is required. The HF-Performer III range has a robust design, meets all relevant international safety and performance standards and is energy efficient (CELMA EEI A2). The ballast is primarily designed for Indoor application. For outdoor application, the luminaire should be minimum Class II need to be sufficiently protected against water & dust. The installation should also be guard against any lightning surge or any other necessary electrical protection as deemed in such typical installation & application.

Benefits

- Robust design that meets all relevant international safety and performance standards, in combination with good energy efficiency
- Automatic restart (after voltage dip or lamp exchange) ensures easy operation and hassle-free re-lamping.
- Suitable for DC emergency operation, 186 to 275 V (at -10 °C) and in line with IEC/EN 60598-2-22 luminaire norms

Features

- 50,000-hour lifetime at maximum case temperature, combined with over 60,000 on/off switches on one lamp
- Programmed, flicker-free, pre-heated start (< 2.0 s) which allows the lamp to be switched on and off without reducing useful lamp life
- Active power factor correction to ensure constant light, irrespective of mains-voltage fluctuations
- The unit is protected against excessive mains voltage and incorrect connections.

HF-Performer III for PL-T/C lamps

Application

- Ideal for commercial indoor lighting applications where it is necessary to reduce the wattage per square meter or operating costs
- Used with movement-detection control systems like Philips OccuPlus
- Mainly for indoor applications such as spotlights, downlights and recessed fixtures used primarily in retail stores, office buildings, supermarkets, hotels and convenience stores
- Industrial premises with long operating hours

Versions



HF-P 118 PL-T/C III 220-240V 50/60Hz

Dimensional drawing

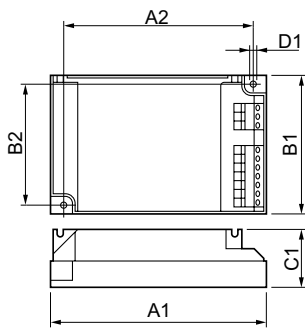

Product	D1	C1	A1	A2	B1	B2
HF-P 1/218 PL-T/C III 220-240V	4.2 mm	30.0 mm	103.8 mm	93.5 mm	67.8 mm	57.5 mm
HF-P 1/226 PL-T/C III 220-240V	4.2 mm	30.0 mm	103.8 mm	93.5 mm	67.8 mm	57.5 mm

Operating and Electrical

Input Frequency	50 to 60 Hz
Input Voltage	220 to 240 V

General Information

Number Of Products On MCB (16A Type B) (Nom)	28
Number Of Lamps	2 piece/unit
Lamp Type	PL-T/C

Mechanical and Housing

Housing	S 103x67x30
---------	-------------

Approval and Application

HF-Performer III for PL-T/C lamps

Order Code	Full Product Name	Energy Efficiency Index
913700648666	HF-P 1/218 PL-T/C III 220-240V	A2 BAT

Order Code	Full Product Name	Energy Efficiency Index
913700648866	HF-P 1/226 PL-T/C III 220-240V	A2/A2 BAT

System characteristics

Order Code	Full Product Name	Lamp Power On	Rated Ballast-
		PL-T/C	Lamp Power
913700648666	HF-P 1/218 PL-T/C III 220-240V	31.2/16 W	18 W

Order Code	Full Product Name	Lamp Power On	Rated Ballast-
		PL-T/C	Lamp Power
913700648866	HF-P 1/226 PL-T/C III 220-240V	45/23.63 W	26 W

