



HF-Essential for TL5/TL-D

HF-Essential for TL5/TL-D

Essentially smart and reliable HF-Essential is the most cost-effective, slim and affordable ballast to reliably operate a fluorescent lamp. It is also the ideal entry-level product for EM system users who want to enjoy the benefits offered by electronic ballasts. The cost-saving and reliable HF-Essential has an energy efficiency class A2, and its robust design meets all relevant international safety and performance standards. HF-Essential is intended for use with indoor lighting fixtures such as recessed luminaires, which are largely used in office, industrial, hotel, restaurant and other applications. The ballast is primarily designed for indoor application. For outdoor application, the luminaire should be minimum Class II and need to be sufficiently protected against water & dust. The installation should also be guard against any lightning surge or any other necessary electrical protection as deemed in such typical installation & application.

Benefits

- Automatic restart (after voltage dip or lamp replacement) ensures easy operation and hassle-free re-lamping
- DC emergency operation and EMC compliant to EN 55015 2006 + A1 2007
- Suitable for luminaires in protection class I and, after testing, class II

Features

- Complies with CE and Kema
- Robust design for 45,000 hours lifetime at $T_a=50\text{ }^\circ\text{C}$ and over 6,000 on/off switching operations on one lamp
- Energy efficiency class: A2
- Failure rate of 0.3% per 1,000 hours at $T_c \text{ max} = 75\text{ }^\circ\text{C}$
- Igniter and capacitor not required; flicker-free and noiseless

HF-Essential for TL5/TL-D

Application

- Ideal for applications where there is a need to reduce the wattage per square meter or to reduce operating costs
- Indoor applications such as office buildings, hospitals, supermarkets, department stores, homes and schools

Versions



HF-E 118 TL-D 220-240 50/60Hz

Dimensional drawing

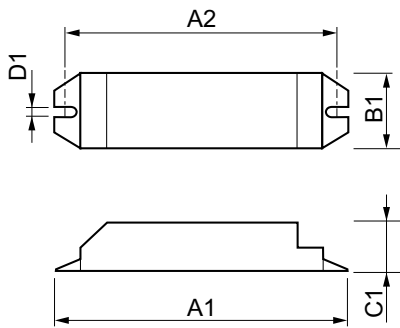

| Product | D1 | C1 | A1 | A2 | B1 |
|-------------------------------|--------|---------|----------|----------|---------|
| HF-E 118 TL-D 220-240 50/60Hz | 4.2 mm | 28.0 mm | 150.0 mm | 136.0 mm | 40.0 mm |
| HF-E 136 TL-D 220-240 50/60Hz | 4.2 mm | 28.0 mm | 150.0 mm | 136.0 mm | 40.0 mm |
| HF-E 236 TL-D 220-240 50/60Hz | 4.2 mm | 30.0 mm | 211.0 mm | 197.0 mm | 40.0 mm |
| HF-E 418 TL-D 220-240 50/60Hz | 4.2 mm | 30.0 mm | 211.0 mm | 197.0 mm | 40.0 mm |

Approval and Application

Energy Efficiency Index A2

Operating and Electrical

Input Frequency 50 to 60 Hz
 Input Voltage 220 to 240 V

General Information

Lamp Type TL-D

General Information

| Order Code | Full Product Name | Number Of Lamps |
|--------------|-------------------------------|-----------------|
| 913713038766 | HF-E 118 TL-D 220-240 50/60Hz | 1 piece/unit |
| 913713038866 | HF-E 136 TL-D 220-240 50/60Hz | 1 piece/unit |

| Order Code | Full Product Name | Number Of Lamps |
|--------------|-------------------------------|-----------------|
| 913713039166 | HF-E 236 TL-D 220-240 50/60Hz | 2 piece/unit |
| 913713039266 | HF-E 418 TL-D 220-240 50/60Hz | 4 piece/unit |

HF-Essential for TL5/TL-D

Mechanical and Housing

| Order Code | Full Product Name | Housing |
|--------------|-------------------------------|-------------|
| 913713038766 | HF-E 118 TL-D 220-240 50/60Hz | L 150x40x28 |
| 913713038866 | HF-E 136 TL-D 220-240 50/60Hz | L 150x40x28 |

| Order Code | Full Product Name | Housing |
|--------------|-------------------------------|------------|
| 913713039166 | HF-E 236 TL-D 220-240 50/60Hz | L211x40x30 |
| 913713039266 | HF-E 418 TL-D 220-240 50/60Hz | L211x40x30 |

System characteristics

| Order Code | Full Product Name | Rated Ballast- | |
|--------------|----------------------------------|--------------------|------------|
| | | Lamp Power On TL-D | Lamp Power |
| 913713038766 | HF-E 118 TL-D 220-240 50/60Hz | 14.4/15.1/15.7 W | 18 W |
| 913713038866 | HF-E 136 TL-D 220-240 50/60Hz | 30.7/32.7/35.1 W | 36 W |

| Order Code | Full Product Name | Rated Ballast- | |
|--------------|----------------------------------|--------------------|------------|
| | | Lamp Power On TL-D | Lamp Power |
| 913713039166 | HF-E 236 TL-D 220-240 50/60Hz | 28/29.8/31.6 W | 36 W |
| 913713039266 | HF-E 418 TL-D 220-240 50/60Hz | 15.1/15.7/15.7 W | 18 W |

