



MASTER LEDspot ExpertColor AR111



MAS ExpertColor 14.8-75W 930 AR111 45D

MASTER LEDspot LV ExpertColor creates a warm and comfortable ambience for hospitality venues, homes and restaurants. It creates such an ambience with superior lighting that has a customized spectrum, high CRI, and deep dimming feature. The result? A beautiful lighting experience. What's more, the innovative, trimless lens design will suit almost any interior decor with its clean and neat look. In addition, you can take advantage of the full ExpertColor family, which also includes LEDspot MV and LEDspot Par lamps.

Product data

General Information	
Cap-Base	G53
Nominal lifetime	40,000 hour(s)
Switching Cycle	50,000
Lighting Technology	LED
Flux measurement reference	Narrow Cone
CE mark	Yes
EU RoHS compliant	Yes
Light Technical	
Color Code	930 [CCT of 3000K]
Beam Angle (Nom)	45 degree(s)
Luminous Flux	875 lm
Luminous Intensity (Nom)	1,300 cd
Color Designation	White (WH)
Correlated Color Temperature (Nom)	3000 K
Luminous Efficacy (rated) (Nom)	59 lm/W
Color Consistency	<4

Color rendering index (CRI)	95
LLMF At End Of Nominal Lifetime (Nom)	70 %
Luminous Flux in 90° Cone (Rated)	875 lm
Photobiological safety according to EN 62471	RG1
Operating and Electrical	
Line Frequency	50 to 60 Hz
Input Frequency	50 to 60 Hz
Power Consumption	14.8 W
Lamp Current (Nom)	1,500 mA
Wattage Equivalent	75 W
Starting Time (Nom)	0.5 s
Warm-up time to 60% light	0.5 s
Power Factor (Fraction)	0.7
Voltage (Nom)	ac electronic 12 V

MASTER LEDspot ExpertColor AR111

Temperature

T-Case Maximum (Nom)	85 °C
----------------------	-------

Controls and Dimming

Dimmable	Only with specific dimmers
----------	----------------------------

Mechanical and Housing

Bulb Finish	Clear
Bulb Shape	AR111

Approval and Application

Energy Efficiency Class	G
Suitable For Accent Lighting	Yes
Energy Consumption kWh/1000 h	15 kWh
EPREL Registration Number	648246
EyeComfort	Yes

Application Conditions

can it be used in closed luminaires	No
-------------------------------------	----

Product Data

Order product name	MAS ExpertColor 14.8-75W 930 AR111 45D
Full product name	MAS ExpertColor 14.8-75W 930 AR111 45D
Full product code	871951433385700
Order code	929003042902
Material Nr. (12NC)	929003042902
Numerator - Quantity Per Pack	1
EAN/UPC - Product/Case	8719514333857
Numerator - Packs per outer box	6
EAN/UPC - Case	8719514333864

Dimensional drawing

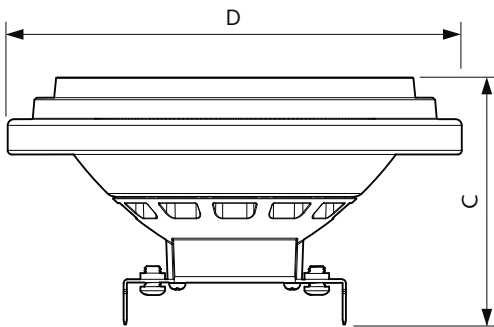

Product	D	C
MAS ExpertColor 14.8-75W 930 AR111 45D	111 mm	61 mm

Photometric data

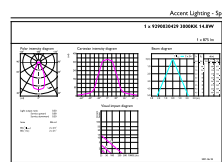
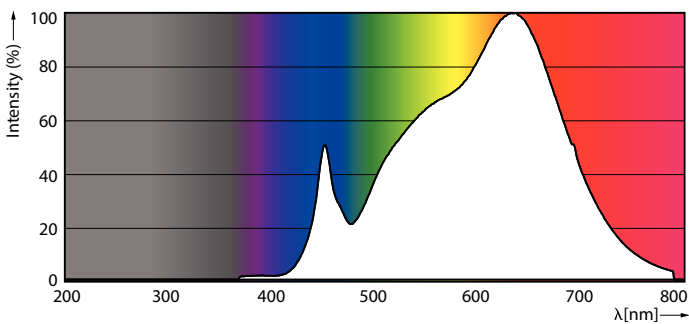

Spectral Power Distribution Colour - MAS ExpertColor 14.8-75W 930 AR111 45D

Accent Lighting Spots - MAS ExpertColor 14.8-75W 930 AR111 45D

MASTER LEDspot ExpertColor AR111

Photometric data

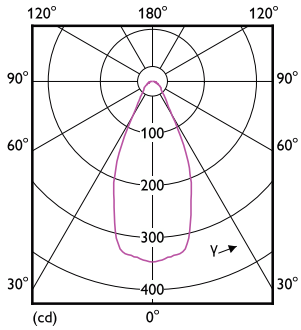

Light Distribution Diagram - MAS ExpertColor 14.8-75W 930 AR111 45D

Lifetime



Life Expectancy Diagram - MAS ExpertColor 14.8-75W 930 AR111 45D



Lumen Maintenance Diagram - MAS ExpertColor 14.8-75W 930 AR111 45D

