



CorePro LED PLC 2P

CorePro LED PLC 6.5W 840 2P G24d-2

CorePro LED PLC 2P integrates a LED light source into a traditional fluorescent form factor. This product is the ideal solution for uplampping in general lighting applications: it meets basic lighting requirements, offers significant energy savings, and is environmentally friendly.

Product data

General Information		Starting Time (Nom)	
Cap-Base	G24D-2 [G24d-2]		0.5 s
EU RoHS compliant	Yes	Warm Up Time to 60% Light (Nom)	0.5 s
Nominal Lifetime (Nom)	30000 h	Power Factor (Nom)	0.9
Switching Cycle	50000X	Voltage (Nom)	220-240 V
Flux measurement reference	Sphere		
Light Technical		Temperature	
Color Code	840 [CCT of 4000K]	T-Ambient (Max)	35 °C
Beam Angle (Nom)	120 °	T-Ambient (Min)	-20 °C
Luminous Flux (Nom)	700 lm	T-Storage (Max)	65 °C
Color Designation	Cool White (CW)	T-Storage (Min)	-40 °C
Correlated Color Temperature (Nom)	4000 K	T-Case Maximum (Nom)	65 °C
Luminous Efficacy (rated) (Nom)	92.31 lm/W	Controls and Dimming	
Color Consistency	<6	Dimmable	No
Color Rendering Index (Nom)	83	Mechanical and Housing	
LLMF At End Of Nominal Lifetime (Nom)	70 %	Product Length	100 mm
		Bulb Shape	Tube, single-ended
Operating and Electrical		Approval and Application	
Input Frequency	50 to 60 Hz	Energy Efficiency Class	F
Power (Nom)	6.5 W	Energy Saving Product	Yes
Lamp Current (Max)	35 mA		
Lamp Current (Min)	25 mA		

CorePro LED PLC 2P

Approval Marks	TUV CE marking RoHS compliance KEMA Keur certificate
Energy Consumption kWh/1000 h	7 kWh
EPREL Registration Number	403557
Product Data	
Full product code	871869654129600
Order product name	CorePro LED PLC 6.5W 840 2P G24d-2

EAN/UPC - Product	8718696541296
Order code	929001201502
Numerator - Quantity Per Pack	1
Numerator - Packs per outer box	10
Material Nr. (12NC)	929001201502
Net Weight (Piece)	0.077 kg

Dimensional drawing



Product	D1	D2	A1	A2	A3
CorePro LED PLC 6.5W 840 2P G24d-2	24.3 mm	28.4 mm	105.8 mm	125 mm	147.6 mm

LEDtube PLC 6.5W G24d-2/840 2P

Photometric data

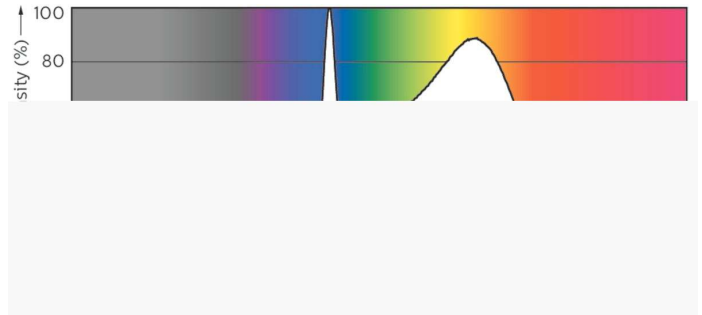
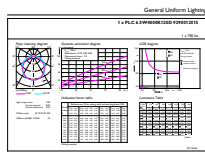

LEDtube PLC 100mm 7W G24D-2 840 700lm

LEDtube PLC 100mm 9W G24Q-3 840 1000lm

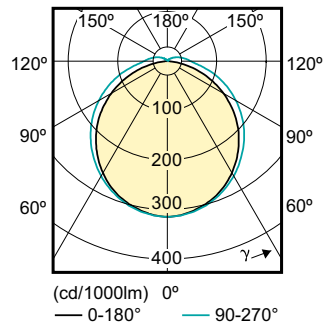

CorePro LED PLC 2P

Lifetime

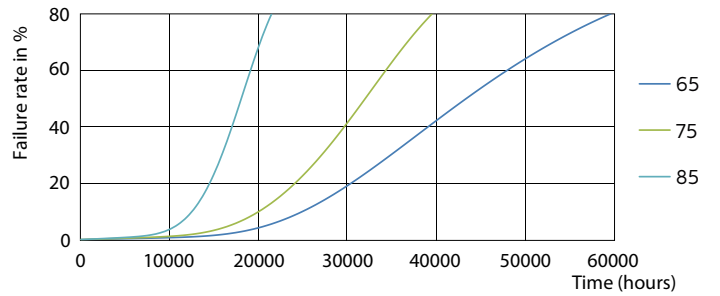
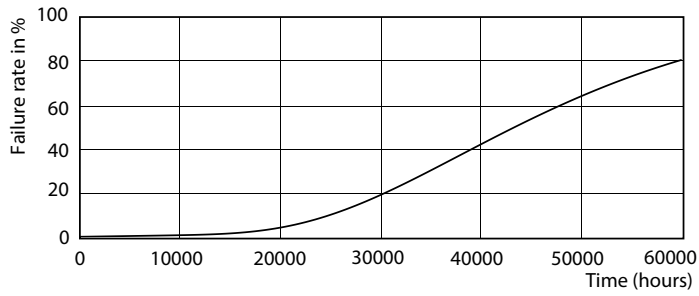

LEDtube PLC 100mm 7W G24D-2 830 650lm

LEDtube PLC 100mm 7W G24D-2 830 650lm

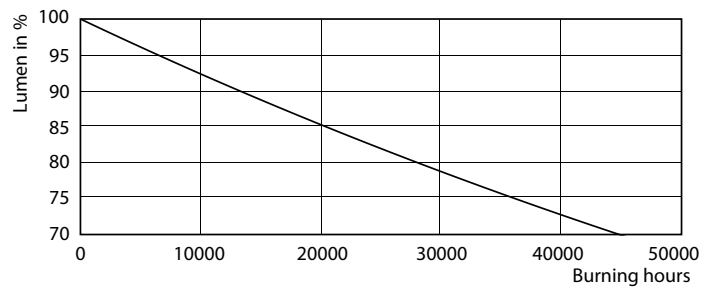
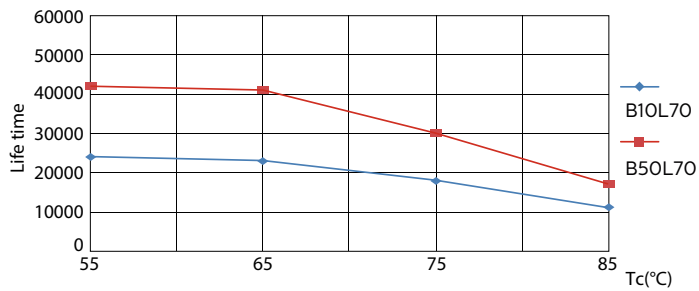

LEDtube PLC 100mm 7W G24D-2 830 650lm

LEDtube PLC 100mm 7W G24D-2 830 650lm

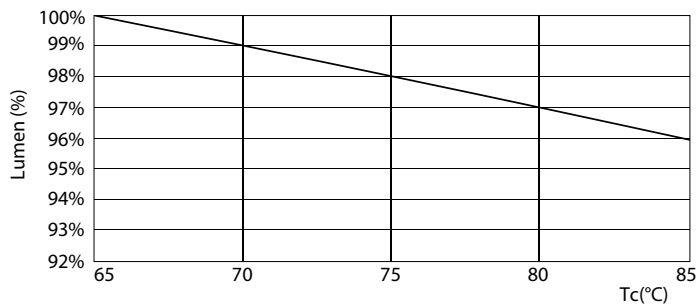

LEDtube PLC 100mm 7W G24D-2 830 650lm

CorePro LED PLC 2P

