

MASTER LEDtube EM/ Mains T8

Master LEDTube 1200 mm 18W 865 T8 I W

The Philips MASTER LEDtube integrates a LED light source into a traditional fluorescent form factor. Its unique design creates a perfectly uniform visual appearance which cannot be distinguished from traditional fluorescent. For those that are looking for value for money within limited budget and re-lamping efforts for better light effect and lifetime.

Warnings and Safety

- NOTES: The overall energy efficiency and light distribution of any installation that uses these lamps are determined by the design of the installation.

Product data

General Information		LLMF At End Of Nominal Lifetime (Nom) 70 %	
Cap-Base	G13 [Medium Bi-Pin Fluorescent]	Operating and Electrical	
EU RoHS compliant	Yes	Input Frequency	50 to 60 Hz
Nominal Lifetime (Nom)	40000 h	Power (Nom)	18 W
Switching Cycle	50000X	Starting Time (Nom)	0.5 s
Light Technical		Warm Up Time to 60% Light (Nom)	instant full light s
Color Code	865 [CCT of 6500K]	Power Factor (Nom)	0.92
Beam Angle (Nom)	160 °	Voltage (Nom)	100-240 V
Luminous Flux (Nom)	2100 lm	Temperature	
Color Designation	Cool Daylight	T-Ambient (Max)	45 °C
Correlated Color Temperature (Nom)	6500 K	T-Ambient (Min)	-20 °C
Luminous Efficacy (rated) (Nom)	116.67 lm/W	T-Storage (Max)	65 °C
Color Consistency	<6	T-Storage (Min)	-40 °C
Color Rendering Index (Nom)	82		

MASTER LEDtube EM/Mains T8

T-Case Maximum (Nom)	70 °C
Controls and Dimming	
Dimmable	No
Mechanical and Housing	
Product Length	1200 mm
Approval and Application	
Energy Efficiency Label (EEL)	A+
Energy Saving Product	Yes
Suitable For Accent Lighting	No
Approval Marks	CE marking RoHS compliance KEMA Keur certificate

Energy Consumption kWh/1000 h	18 kWh
Product Data	
Full product code	871869652406000
Order product name	Master LEDTube 1200 mm 18W 865 T8 I W
EAN/UPC - Product	8718696524060
Order code	929001187812
Numerator - Quantity Per Pack	1
Numerator - Packs per outer box	10
Material Nr. (12NC)	929001187812
Net Weight (Piece)	0.230 kg

Dimensional drawing

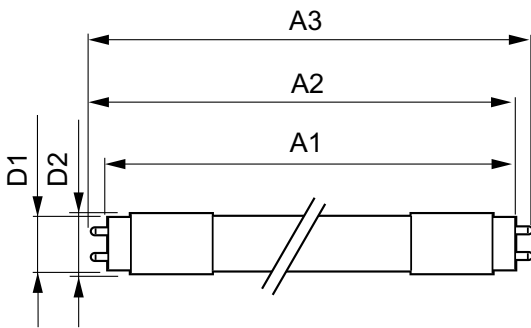

LEDtube 1200mm 18W/865 T8 I W

Product	D1	D2	A1	A2	A3
Master LEDTube 1200 mm 18W 865 T8 I W	25.6 mm	27.8 mm	1198.1 mm	1205.2 mm	1212.3 mm

Photometric data

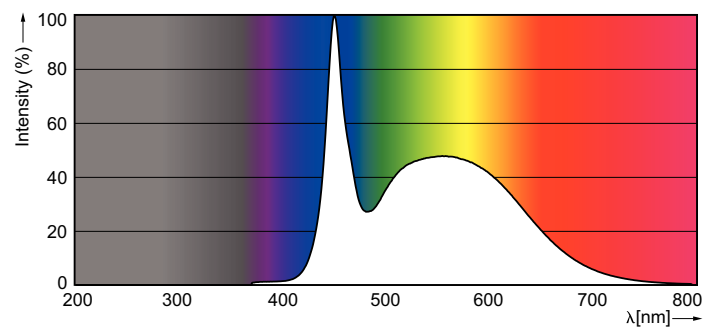
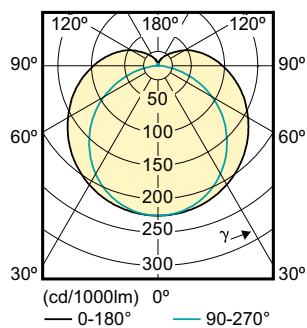

SDPO_MLEDGA_0069-Spectral Power distribution

MASTER LEDtube EM/Mains T8

Lifetime

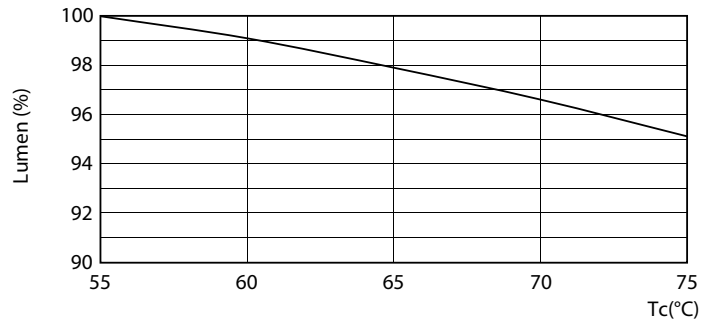
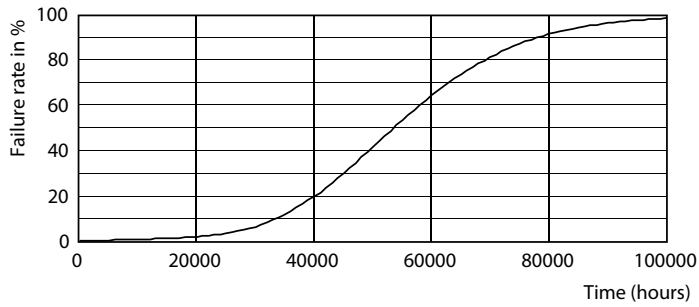

LEDtube 1200 mm 18W 840 T8 I W

LEDtube 1200 mm 18W 840 T8 I W LumenVsTc

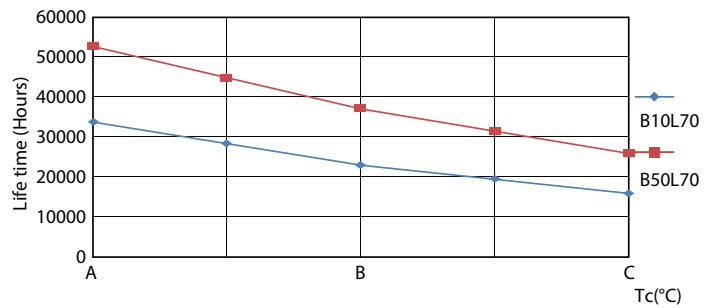
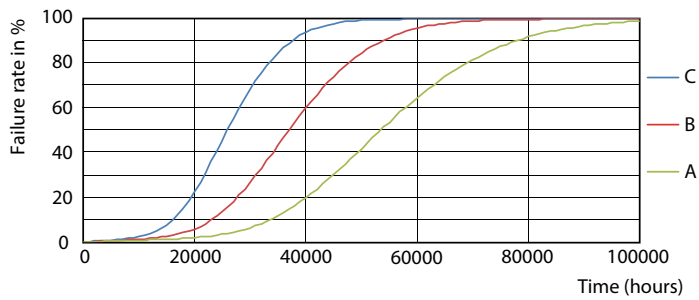

LEDtube 1200 mm 18W 840 T8 I W FailureRate

LEDtube 1200 mm 18W 840 T8 I W LifetimeVsTc

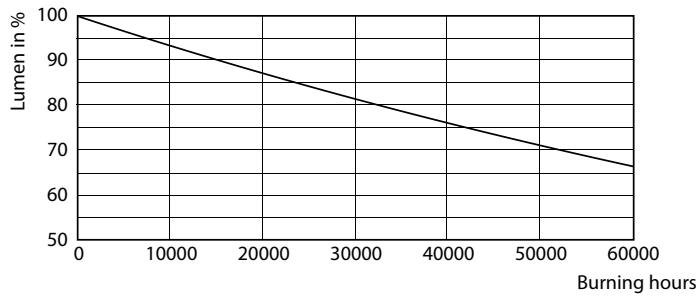

LEDtube 1200 mm 18W 840 T8 I W

MASTER LEDtube EM/Mains T8

