

EB-Certalume for TL-D lamps

EB-Ci 1-2 36W / 1-4 18W 220-240V 50/60Hz

Affordable, reliable, high-frequency electronic ballast for TL-D fluorescent lamps, ideal alternative to electromagnetic fluorescent systems. The cost-saving and reliable EB-C has energy efficiency class A2, and its robust design meets all necessary international standards for safety and EMC. The ballast is primarily designed for indoor application. For outdoor application, the luminaire should be minimum Class II need to be sufficiently protected against water & dust. The installation should also be guard against any lightning surge or any other necessary electrical protection as deemed in such typical installation & application.

Product data

General Information		Earth Leakage Current (Max)	
Lamp Type	TL-D		0.5 mA
Number of Lamps	1-4 piece/unit	Inrush Current Width	0.35 ms
Suitable For Outdoor Use	No	Ballast Factor (Nom)	1
Number of Products on MCB (16A Type B) (Max)	28	Power Factor (Max)	0.98
Automatic Restart	Yes	Power Factor (Min)	0.90
		Input Power (Max)	70.2 W
		Input Power (Min)	21.3 W
		Power Losses (Max)	6.2 W
		Power Losses (Nom)	3.3 W
		Inrush Current Peak (Max)	19 A
		Rated Lamp Power	18-36 W
Operating and Electrical		Wiring	
Input Voltage	220-240 V	Connector Type Input Terminals	Insert
Input Frequency	50 or 60 Hz	Cable Capacity Output Wires Mutual (Max)	150 pF
Operating Frequency (Nom)	42-60 kHz	Connector Type Output Terminals	Insert
Ignition Method	Warm Start	Cable Length Hot Wiring	0.75 m
Crestfactor (Max)	1.7		
Ignition Time (Nom)	2.0 s		
Mains Voltage Performance (AC)	-10%~+10%		
Mains Voltage Safety (AC)	198...264V		

EB-Certalume for TL-D lamps

Wire Striplength	7.5-8.5 mm
Input Terminal Cross Section	0.50-1.50 mm ²
Output Terminal Cross Section	0.50-1.50 mm ²
Cable Capacity Output Wires to Earth (Max)	150 pF
Connector Type	Insert

System characteristics

Rated Lamp Power on TL-D	18-36 W
System Power on TL-D	21.3-68.2 W
Lamp Power on TL-D	18.0-31.0 W
Power Loss on TL-D	3.3-6.2 W

Temperature

T-Ambient (Max)	50 °C
T-Case Lifetime (Max)	75 °C
T-Case Maximum (Max)	75 °C
T-Ignition (Max)	50 °C
T-Ignition (Min)	-10 °C

Mechanical and Housing

Housing Material	Plastic
Housing	L210x30x26mm

Emergency Operation

Battery Voltage Lamp Ignition	165-253 V
-------------------------------	-----------

Approval and Application

Energy Efficiency Index	A2
-------------------------	----

IP Classification	IP 20 [Ingress Protection 20]
EMI 9 kHz ... 30 MHz	EN55015
EMI 30 MHz ... 1000 MHz	EN 55015
Safety Standard	IEC 61347-2-3, IEC 61347-1
Quality Standard	ISO 9001
Environmental Standard	ISO 14001
EMC Immunity Standard	EN 55015
Vibration Standard	IEC60068-2-6 F c
Bumps Standard	Not specified
Approval Marks	CB Certificate CCC certificate TISI marking PSB certification RCM compliance CS Compliance IRAM Compliance SNI Certificate
Temperature Marking	Yes
Hum And Noise Level	< 30 dB(A)

Product Data

Full product code	694793913353600
Order product name	EB-Ci 1-2 36W / 1-4 18W 220-240V 50/60Hz
EAN/UPC - Product	6947939133536
Order code	913713043180
Numerator - Quantity Per Pack	1
Numerator - Packs per outer box	30
Material Nr. (12NC)	913713043180
Net Weight (Piece)	0.080 kg

Dimensional drawing

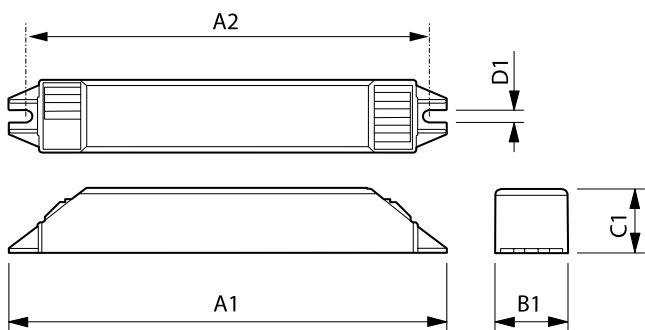

EB-Ci 1-2 36W / 1-4 18W 220-240v 50/60Hz

Product	A1	A2	B1	C1	D1
EB-Ci 1-2 36W / 1-4 18W 220-240V 50/60Hz	210 mm	200 mm	30 mm	26 mm	4.3 mm

EB-Certalume for TL-D lamps

