



UniPoint

BGP312 5LED 3000K WB

Our UniPoint is designed to produce both general and accent lighting while concealing the body of the device, allowing only the light to be exposed. This design can be used to change the surroundings by adding subtle or dramatic contrasting effects. It also includes exclusive features such as energy efficiency, chromatic quality and miniaturization. We guarantee extreme reliability and high level of resistance to adverse weather conditions and vandalism

Product data

General Information	
Light source color	830 warm white
Light source replaceable	No
Driver/power unit/transformer	Electronic transformer
Driver included	No
Optical cover/lens type	Glass bowl/cover
Luminaire light beam spread	40°
Control interface	-
Connection	Flying leads/wires
Cable	Cable without plug 2-pole
Protection class IEC	Safety class III
CE mark	-
Warranty period	3 years
Optic type outdoor	Wide beam angle 42°
Constant light output	No
EU RoHS compliant	Yes
Light source engine type	LED
Light Technical	
Standard tilt angle posttop	-

Standard tilt angle side entry	-
Operating and Electrical	
Input Voltage	24 DC V
Input Frequency	45 to 66 Hz
Inrush current	1 A
Inrush time	10 ms
Power Factor (Min)	0.97
Controls and Dimming	
Dimmable	No
Mechanical and Housing	
Housing Material	Aluminum die cast
Reflector material	Glass
Optical cover/lens material	Glass
Mounting device	Allen screw fixation
Optical cover/lens shape	Conical
Optical cover/lens finish	Textured
Overall length	123.5 mm
Overall height	95 mm

Overall diameter	90 mm
Color	Dark gray

Approval and Application

Ingress protection code	IP66 [Dust penetration-protected, jet-proof]
Mech. impact protection code	IK06 [1 J]

Initial Performance (IEC Compliant)

Initial luminous flux (system flux)	595 lm
Luminous flux tolerance	+/-10%
Initial LED luminaire efficacy	59 lm/W
Init. Corr. Color Temperature	3000 K
Init. Color Rendering Index	>75
Initial chromaticity	SDCM<5
Initial input power	10 W
Power consumption tolerance	+/-10%

Application Conditions

Ambient temperature range	-20 to +45 °C
---------------------------	---------------

Product Data

Full product code	911401710872
Order product name	BGP312 5LED 3000K WB
Order code	911401710872
Numerator - Quantity Per Pack	1
Numerator - Packs per outer box	9
Material Nr. (12NC)	911401710872
Net Weight (Piece)	0.777 kg



Dimensional drawing

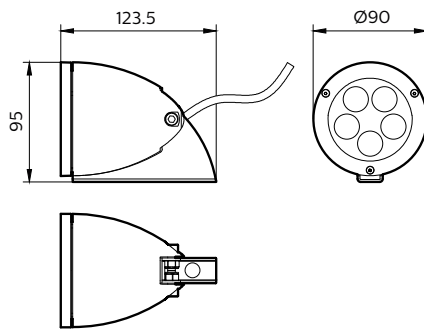

BGP312 UniPoint

