



LuxSpace G4

DN592B LED25/940 PSU C D150 WH MB GC

Reflector

LuxSpace Gen4 is the a new LED downlight range combining light comfort and leading performance with luxury looking

Product data

General information	
Light source color	940 neutral white
Light source replaceable	No
Number of gear units	1 unit
Driver/power unit/transformer	Power supply unit external
Driver included	Yes
Optic type	Facetted reflector with beam angle 30°
Optical cover/lens type	Reflector
Control interface	-
Connection	Push-in connector with 2 poles and pull relief
Protection class IEC	Safety class II
Glow-wire test	Temperature 650 °C, duration 30 s
Flammability mark	For mounting on normally flammable surfaces
CE mark	CE mark
Warranty period	3 years
Constant light output	No
Number of products on MCB of 16 A type B	34
EU RoHS compliant	Yes
Light source engine type	LED

Operating and electrical	
Input Voltage	220 to 240 V
Input Frequency	50 or 60 Hz
Inrush current	6.1 A
Inrush time	0.31 ms
Power Factor (Min)	0.9

Controls and dimming	
Dimmable	No

Mechanical and housing	
Housing Material	Aluminum die cast
Reflector material	Polycarbonate aluminum coated
Optic material	Polycarbonate
Optical cover/lens material	Polycarbonate
Fixation material	Steel
Optical cover/lens finish	Textured
Overall length	0 mm
Overall width	0 mm
Overall height	100 mm
Overall diameter	162 mm
Color	White and black

LuxSpace G4

Dimensions (Height x Width x Depth)	100 x 0 x 0 mm
-------------------------------------	----------------

Approval and application

Ingress protection code	IP20 [Finger-protected]
Mech. impact protection code	IK03 [0.3 J]

Initial performance (IEC compliant)

Initial luminous flux (system flux)	2260 lm
Luminous flux tolerance	+/-10%
Initial LED luminaire efficacy	98 lm/W
Init. Corr. Color Temperature	4000 K
Init. Color Rendering Index	>90
Initial input power	23 W
Power consumption tolerance	+/-10%

Over time performance (IEC compliant)

Driver failure rate at 5000 h	1%
Median useful life L70B50	50000 h
Median useful life L80B50	50000 h

Median useful life L90B50	21000 h
---------------------------	---------

Application conditions

Ambient temperature range	-20 to +40 °C
Maximum dim level	Not applicable

Product data

Full product code	911401544841
Order product name	DN592B LED25/940 PSU C D150 WH MB
	GC
Order code	911401544841
Numerator - Quantity Per Pack	1
Numerator - Packs per outer box	1
Material Nr. (12NC)	911401544841
Net Weight (Piece)	0.799 kg



Dimensional drawing

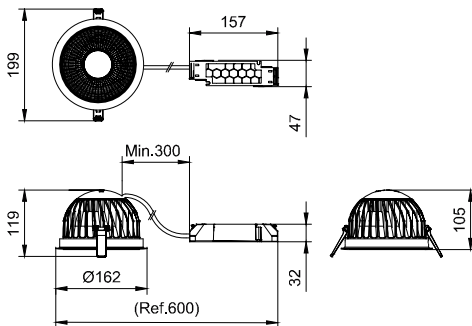

DN592B LED25/940 PSU C D150 WH MB GC

