



LuxSpace G4

DN590B LED15/840 PSD C D125 WH MB GC

Reflector

LuxSpace Gen4 is the a new LED downlight range combining light comfort and leading performance with luxury looking

Product data

General information	
Light source color	840 neutral white
Light source replaceable	No
Number of gear units	1 unit
Driver/power unit/transformer	Power supply unit external
Driver included	Yes
Optic type	Facetted reflector with beam angle 30°
Optical cover/lens type	Reflector
Control interface	DALI
Connection	Plug-in connector 3-pole Wieland/Adels compatible and 2x 2-pole control signal for light regulation
Protection class IEC	Safety class I
Glow-wire test	Temperature 650 °C, duration 30 s
Flammability mark	For mounting on normally flammable surfaces
CE mark	CE mark
Warranty period	3 years
Constant light output	No
Number of products on MCB of 16 A type B	24
EU RoHS compliant	Yes
Light source engine type	LED

Operating and electrical	
Input Voltage	220 to 240 V
Input Frequency	50 or 60 Hz
Inrush current	20.4 A
Inrush time	0.195 ms
Power Factor (Min)	0.9

Controls and dimming	
Dimmable	Yes

Mechanical and housing	
Housing Material	Aluminum die cast
Reflector material	Polycarbonate aluminum coated
Optic material	Polycarbonate
Optical cover/lens material	Polycarbonate
Fixation material	Steel
Optical cover/lens finish	Textured
Overall length	0 mm
Overall width	0 mm
Overall height	90 mm
Overall diameter	137 mm
Color	White and black

LuxSpace G4

Dimensions (Height x Width x Depth)	90 x 0 x 0 mm
Approval and application	
Ingress protection code	IP20 [Finger-protected]
Mech. impact protection code	IK03 [0.3 J]
Initial performance (IEC compliant)	
Initial luminous flux (system flux)	1500 lm
Luminous flux tolerance	+/-10%
Initial LED luminaire efficacy	111 lm/W
Init. Corr. Color Temperature	4000 K
Init. Color Rendering Index	>90
Initial input power	13.5 W
Power consumption tolerance	+/-10%
Over time performance (IEC compliant)	
Driver failure rate at 5000 h	1 %
Median useful life L70B50	50000 h

Median useful life L80B50	50000 h
Median useful life L90B50	21000 h
Application conditions	
Ambient temperature range	-20 to +40 °C
Maximum dim level	1%
Product data	
Full product code	911401540341
Order product name	DN590B LED15/840 PSD C D125 WH MB GC
Order code	911401540341
Numerator - Quantity Per Pack	1
Numerator - Packs per outer box	1
Material Nr. (12NC)	911401540341
Net Weight (Piece)	0.499 kg



Dimensional drawing

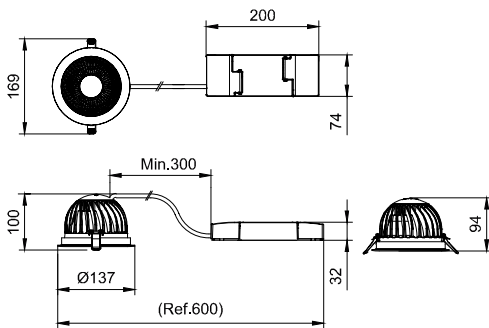

DN590B LED15/840 PSD C D125 WH MB GC

