



HID-PrimaVision Xtreme for CPO - Xtreme drivers for the highest reliability

PrimaVision Xtreme for CPO

Highly reliable electronic drivers for CPO lamps; designed to save energy by offering better light efficiency than magnetic drivers and to reduce maintenance costs thanks to 80,000-hour lifetime and integrated lightning protection

Benefits

- Together with the CPO lamp the driver creates the most efficient white-light system in the industry in its power range
- Up to 15% energy saving due to the high driver efficiency (92%) and better wattage control at overvoltage (compared with magnetic ballasts)
- Minimizes maintenance cost due to the Xtreme lifetime of 80,000 hours and integrated lightning protection

Features

- Xtreme long lifetime of 80,000 hours, with minimum 90% survival at $T_c = 80\text{ }^\circ\text{C}$)
- Xtreme lightning protection 10 kV/5 kA
- Xtreme protection against humidity and vibration
- Better lighting efficiency than magnetic ballasts
- Accurate lamp power stabilization of 95-97% over wide mains-voltage range of 180-300 V

PrimaVision Xtreme for CPO

Application

- Residential lighting
- City beautification
- Road/highway lighting

Versions



HID-PV Xt 45 & 60 CPO Q



HID-PV Xt 90 CPO Q



HID-PV Xt 140 CPO Q

Dimensional drawing

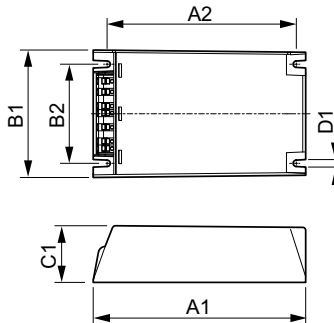

Product	D1	C1	A1	A2	B1	B2
HID-PV Xt 45 CPO Q 208-277V	4.5 mm	40.0 mm	150.0 mm	133.6 mm	90.0 mm	70.0 mm
HID-PV Xt 60 CPO Q 208-277V	4.5 mm	40.0 mm	150.0 mm	133.6 mm	90.0 mm	70.0 mm
HID-PV Xt 90 CPO Q 208-277V	4.5 mm	40.0 mm	150.0 mm	133.6 mm	90.0 mm	70.0 mm
HID-PV Xt 140 CPO Q 208-277V	4.5 mm	40.0 mm	150.0 mm	133.6 mm	90.0 mm	70.0 mm

Controls and Dimming

Regulating Level -

Operating and Electrical

Input Frequency 50 to 60 Hz
Input Voltage 208-240-277 V

General Information

Number Of Lamps 1 piece/unit
Lamp Type CPO

Mechanical and Housing

Housing Q

General Information

PrimaVision Xtreme for CPO

Order Code	Full Product Name	Number Of Products On MCB (16A Type B) (Nom)
913700685466	HID-PV Xt 60 CPO Q 208-277V	11
913700690366	HID-PV Xt 45 CPO Q 208-277V	5

Order Code	Full Product Name	Number Of Products On MCB (16A Type B) (Nom)
913700685566	HID-PV Xt 90 CPO Q 208-277V	5
913700685666	HID-PV Xt 140 CPO Q 208-277V	5

System characteristics

Order Code	Full Product Name	Lamp Power On CPO	Rated Ballast-Lamp Power
913700685466	HID-PV Xt 60 CPO Q 208-277V	60 W	60 W
913700690366	HID-PV Xt 45 CPO Q 208-277V	45 W	45 W

Order Code	Full Product Name	Lamp Power On CPO	Rated Ballast-Lamp Power
913700685566	HID-PV Xt 90 CPO Q 208-277V	90 W	90 W
913700685666	HID-PV Xt 140 CPO Q 208-277V	140 W	140 W

