



The next generation in retail lighting -Simply irresistible

MASTERColor CDM-Rm Elite Mini

The Elite family is at the very top of the MasterColor CDM range, and gives a unique combination of unbeatable light quality and consistent performance over lifetime, while keeping running costs low. The MasterColor DCM Elite MR16 combines the familiar compact shape of MR16 halogen lamps with the performance of ceramic metal halide MasterColor Elite lamps. Suited for accent/decorative lighting, general lighting and downlighting in retail applications; or for outdoor landscaping and architectural effects.

Benefits

- Easy to install and replace, 100% compatible with existing HID systems in markets today
- Miniaturized reflector eliminates need for optical design
- Excellent choice for today's lighting designs

Features

- Sparkling light - 90 CRI with crisp white light (3000K)
- Long life- 12,000 hours rated average life*
- Lamp-to-lamp color consistency
- GX10 twist-and-lock design locks base into place
- Miniaturized
- * Rated average life is the life obtained on the average, from large representative groups of lamps in laboratory tests under controlled conditions at 10 or more operating hours per start. It is based on survival of at least 50% of the lamps and allows for individual lamps or groups of lamps to vary considerably from the average.

MASTERColor CDM-Rm Elite Mini

Application

- Ideal for display lighting, and accent lighting, general lighting and down lighting in retail applications; and for outdoor landscaping and architectural effects in retail and hospitality applications.

Warnings and Safety

- R "WARNING: These lamps can cause serious skin burn and eye inflammation from short wave ultraviolet radiation if outer envelope of the lamp is broken or punctured. Do not use where people will remain for more than a few minutes unless adequate shielding or other safety precautions are used. Certain lamps that will automatically extinguish when the outer envelope is broken or punctured are commercially available." This lamp complies with FDA radiation performance standard 21 CFR subchapter J. (USA:21 CFR 1040.30 Canada: SOR/DORS/80-381)

Versions



GX10 2inch/50mm CCT of 3000K

Dimensional drawing

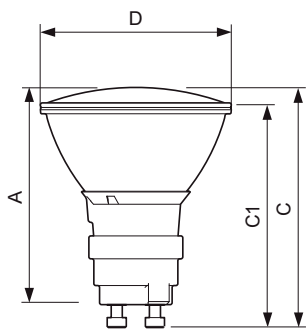

Product	D (max)	D	C (max)	C	C1 (max)	A (max)
MASTERColor CDM-Rm	51 mm	50	65.4 mm	62.75	60.9	59 mm
Elite Mini 20W/830 GX10		mm		mm	mm	
MR16 25D						
MASTERColor CDM-Rm	51 mm	50	65.4 mm	62.75	60.9	59 mm
Elite Mini 20W/830 GX10		mm		mm	mm	
MR16 40D						
MASTERColor CDM-Rm	51 mm	50	65.4 mm	62.75	60.9	59 mm
Elite Mini 35W/930 GX10		mm		mm	mm	
MR16 25D						
MASTERColor CDM-Rm	51 mm	50	65.4 mm	62.75	60.9	59 mm
Elite Mini 35W/930 GX10		mm		mm	mm	
MR16 10D						

MASTERColor CDM-Rm Elite Mini

Controls and dimming

Dimmable	No
----------	----

Operating and electrical

Re-Ignition Time (Min) (Max)	15 min
Warm Up Time To 60% Light (Nom)	120 s

General information

Cap-Base	GX10
Life To 10% Failures (Nom)	10000 h
Life To 20% Failures (Nom)	12000 h
Life To 50% Failures (Nom)	15000 h
Life To 5% Failures (Nom)	9000 h
Operating Position	UNIVERSAL
Switching Cycle	1350X

Light technical

Beam Description	-
Chromaticity Coordinate X (Nom)	0.439
Chromaticity Coordinate Y (Nom)	0.403
Correlated Color Temperature (Nom)	3000 K

Mechanical and housing

Bulb Shape	MR16
------------	------

Approval and application

Order Code	Full Product Name	Energy Consumption kWh/1000 h	Mercury (Hg) Content (Nom)
928191105315	MASTERColor CDM-Rm Elite Mini 20W/830 GX10 MR16 25D	22 kWh	3.5 mg
928191205315	MASTERColor CDM-Rm Elite Mini 20W/830 GX10 MR16 40D	22 kWh	3.5 mg
928194605315	MASTERColor CDM-Rm Elite Mini 35W/930 GX10 MR16 10D	43 kWh	4.7 mg
928194705315	MASTERColor CDM-Rm Elite Mini 35W/930 GX10 MR16 25D	43 kWh	4.7 mg

Operating and electrical

Order Code	Full Product Name	Voltage (Max)	Voltage (Min)	Voltage (Nom)	Power (Nom)
928191105315	MASTERColor CDM-Rm Elite Mini 20W/830 GX10 MR16 25D	100 V	90 V	95 V	20.1 W
928191205315	MASTERColor CDM-Rm Elite Mini 20W/830 GX10 MR16 40D	100 V	90 V	95 V	20.1 W

Order Code	Full Product Name	Voltage (Max)	Voltage (Min)	Voltage (Nom)	Power (Nom)
928194605315	MASTERColor CDM-Rm Elite Mini 35W/930 GX10 MR16 10D	95 V	79 V	87 V	39.1 W
928194705315	MASTERColor CDM-Rm Elite Mini 35W/930 GX10 MR16 25D	95 V	79 V	87 V	39.1 W

Light technical (1/2)

Order Code	Full Product Name	Beam Angle (Nom)	Color Code	Color Rendering Index (Min)	Color Rendering Index (Nom)
928191105315	MASTERColor CDM-Rm Elite Mini 20W/830 GX10 MR16 25D	25 °	830	81	84
928191205315	MASTERColor CDM-Rm Elite Mini 20W/830 GX10 MR16 40D	40 °	830	81	84

Order Code	Full Product Name	Beam Angle (Nom)	Color Code	Color Rendering Index (Min)	Color Rendering Index (Nom)
928194605315	MASTERColor CDM-Rm Elite Mini 35W/930 GX10 MR16 10D	10 °	930	88	90
928194705315	MASTERColor CDM-Rm Elite Mini 35W/930 GX10 MR16 25D	25 °	930	88	90

Light technical (2/2)

MASTERColor CDM-Rm Elite Mini

Order Code	Full Product Name	Lmf At End								
		Of Nominal Lifetime (Nom)	Lumen Maintenance 12000 h (Nom)	Lumen Maintenance 2000 h (Nom)	Lumen Maintenance 4000 h (Nom)	Luminous Efficacy (rated) (Nom)	Luminous Flux (Rated) (Min)	Luminous Flux (Rated) (Nom)	Luminous Intensity (Min)	Luminous Intensity (Nom)
928191105315	MASTERColor CDM-Rm Elite Mini 20W/830 GX10 MR16 25D	70 %	75 %	90 %	85 %	50 lm/W	900 lm	1000 lm	3100 cd	4000 cd
928191205315	MASTERColor CDM-Rm Elite Mini 20W/830 GX10 MR16 40D	70 %	75 %	90 %	85 %	50 lm/W	900 lm	970 lm	1350 cd	1750 cd
928194605315	MASTERColor CDM-Rm Elite Mini 35W/930 GX10 MR16 10D	80 %	85 %	95 %	93 %	60 lm/W	-	2350 lm	14500 cd	17500 cd
928194705315	MASTERColor CDM-Rm Elite Mini 35W/930 GX10 MR16 25D	80 %	85 %	95 %	93 %	60 lm/W	2180 lm	2340 lm	5700 cd	7600 cd

Color Rendering Diagrams

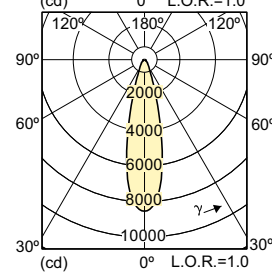
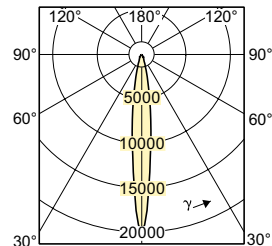
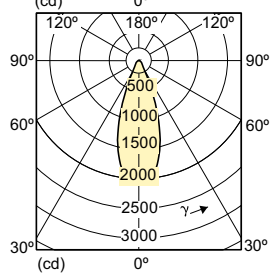
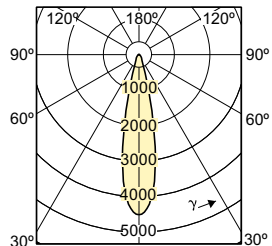

MASTERCOLOR CDM-Rm Elite Mini

Accent Diagrams

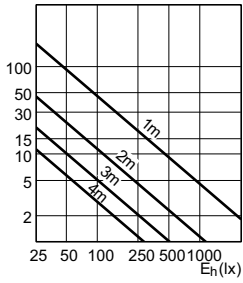

LDAC_CDM-Rm_20W_25D_0003-Accent diagram

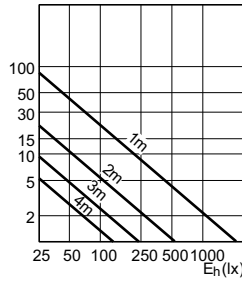

LDAC_CDM-Rm_20W_40D_0003-Accent diagram

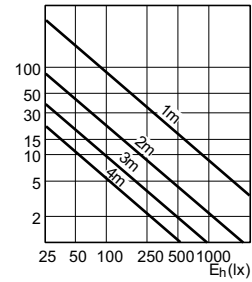

Beam Diagrams

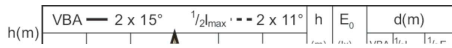

LDBE_CDM-Rm_20W_25D_0003-Beam diagram

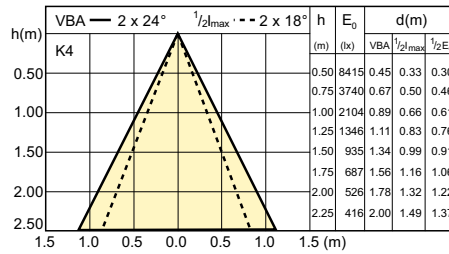

LDBE_CDM-Rm_20W_40D_0003-Beam diagram

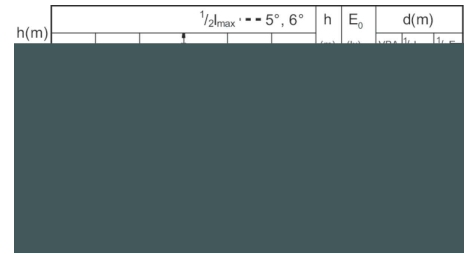

LDBE_CDM-Rm_35W_930_10D-Beam diagram

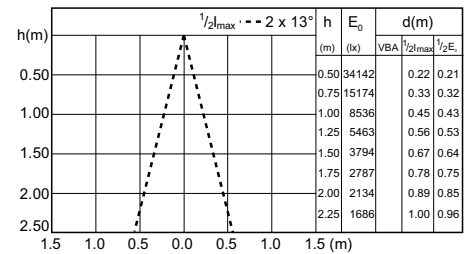

LDBE_CDM-Rm_35W_930_25D-Beam diagram

MASTERColor CDM-Rm Elite Mini

