



DMAL120F

Active Load

Reduces lamp flicker and improves dimming performance

The Philips Dynalite DMAL120F provides correct load conditions for leading edge dimmers, delivering improved dimming performance and reduced lamp flicker in LED and CFL light sources. It achieves this by connecting across the line and neutral wires at any point along a lighting circuit.

DMAL120F

Reduces lamp flicker and improves dimming performance

- **Reduces capital outlay** – Allows continued use of leading edge dimming methodology when lamps have been updated to more efficient LED and CFL technologies.
- **Equally suitable for trailing edge dimming** – Delivers a better dimming range on LED and CFL lightsources.
- **Compact design** – Enables the unit to be mounted directly within the same enclosure as the load controller, or in the field with LED & CFL lamps.
- **Note** – This device is not suitable for elimination of LED flicker resulting from mains supply instability.

Dimensions

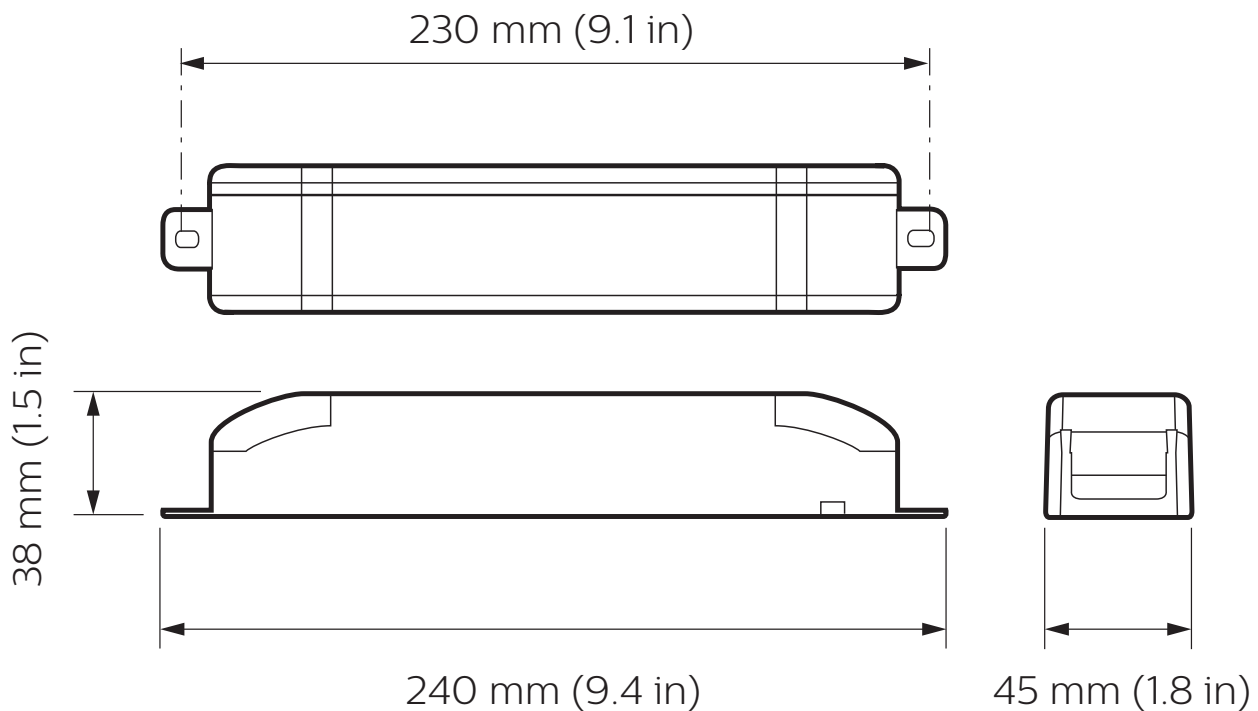

Specifications

Due to continuous improvements and innovations, specifications may change without notice.



DMAL120F
Active Load

Electrical

Supply Type	Dimmer Channel (Leading or Trailing Edge)
Supply Voltage	110-240 VAC
Supply Frequency	50/60 Hz
Supply Power	≤ 6 W
IEC Overvoltage Category	III

Physical

Dimensions (H x W x D)	45 x 240 x 38 mm (1.8 x 9.4 x 1.5 in)
Packed Weight	0.16 kg (0.35 lb)
Construction	ABS plastic
Supply Connection	2 x 45 cm fly lead Line, Neutral
Fly Lead Conductor Size	1.5 mm ²
Fly Lead Insulation	Double insulated, mains rated

Environment

Operating Temperature	0° to 60°C ambient (32° to 140°F)
Storage/Transport Temperature	0° to 70°C ambient (32° to 158°F)
Humidity	0 to 90% non-condensing
IEC Pollution Degree	II

Compliance

Certification	CE, RCM, RoHS
---------------	---------------



Electrical

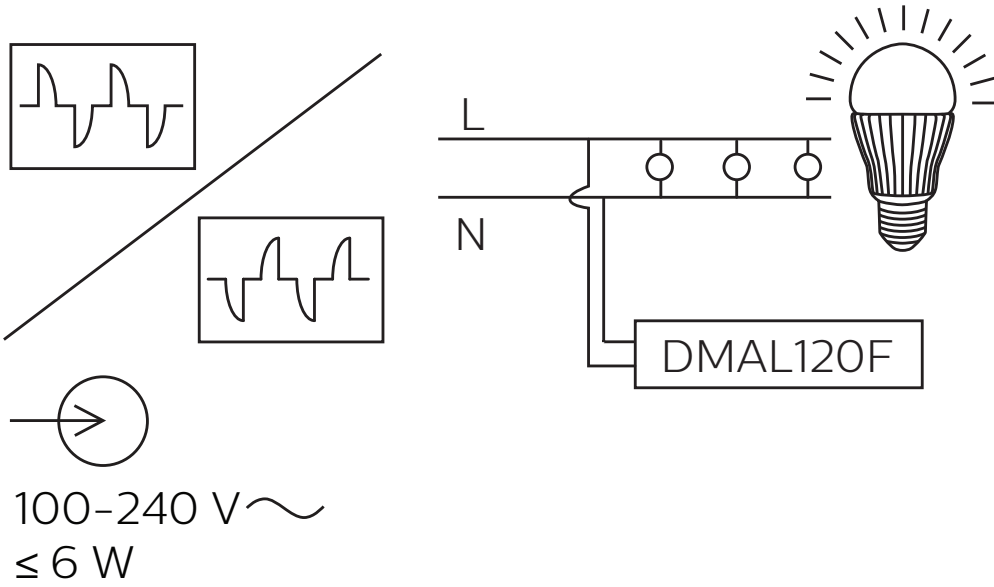

Ordering Code

Product

DMAL120F

Philips 12NC

913703061609



© 2020 Signify Holding. All rights reserved. Specifications are subject to change without notice. No representation or warranty as to the accuracy or completeness of the information included herein is given and any liability for any action in reliance thereon is disclaimed. Philips and the Philips Shield Emblem are registered trademarks of Koninklijke Philips N.V. All other trademarks are owned by Signify Holding or their respective owners.