

# 4 Luminaires





Light filter slots allow the blue infill panel to give a stimulating subtle tint

## Crisp, stimulating light with a subtle tint

- TBS288 is a TL5 electronic office lighting system for both task and general lighting in office spaces and department stores
- It features a super slim, stylish design, easy maintenance and adds a hint of color to office ceilings to enhance the ambience

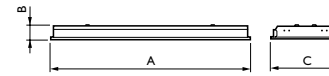

TBS288 2x28 W

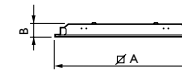

TBS288 3.4x14 W



TBS288 recessed luminaire  
2x28 W



TBS288 recessed luminaire  
3.4x14 W

Dimensions in mm	A	B	C
2x28W	1196	51	296
3x/4x14W	596	51	596

### TBS288

Type	TBS288
Ceiling grid	Module size: modules 600 x 600, 300 x 1200 Exposed tee ceilings
Light source	Fluorescent: 3 x or 4 x TL5 Essential / G5 / 14 W (square version) 2 x TL5 Essential / G5 / 28 W (rectangular version)
Lamp included	Yes (light color 840 or 865)
Gear	Electronic, 220 - 240 V / 50 - 60 Hz (HF)
Optic	High-gloss optic, profiled louvers, blue infill panels (BL)
Connection	Screw connection
Material	Housing: post-painted steel, white Optic: filmed aluminum with anodized aluminum louvers Infill panels: PMMA (blue)
Installation	Individual; lay-in exposed ceiling grid
Main applications	Office

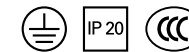

### Preferred selection

Product ID	Weight (kg)	Order Code
TBS288 2xTL5-28W/840 HF G2 BL ID	3.4	9114 009 51380
TBS288 2xTL5-28W/865 HF G2 BL ID	3.4	9114 009 50680

Please contact your local Philips representative for additional configurations

### Preferred selection

Product ID	Weight (kg)	Order Code
TBS288 3xTL5-14W/840 HF G2 BL ID	3.4	9114 009 51480
TBS288 3xTL5-14W/865 HF G2 BL ID	3.4	9114 009 50780
TBS288 4xTL5-14W/840 HF G2 BL ID	3.5	9114 009 51780
TBS288 4xTL5-14W/865 HF G2 BL ID	3.5	9114 009 51080

Please contact your local Philips representative for additional configurations



## For excellence and economy

- TBSI47 is a modular recessed luminaire for TL-D fluorescent lamps in office and shop applications
- It features a wide range of performance optics and a low height of only 78 mm
- A larger spacing between the luminaires and still having an excellent lighting homogeneity is achieved by the well designed anodized aluminium optic
- If used with electronic gear, energy consumption is reduced by up to 25%

### Dimensions in mm

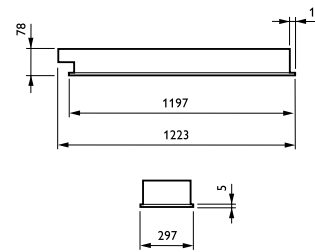

TBSI47 (2x36W)

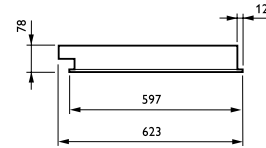

TBSI47 (4x18W)

### TBSI47

Type	TBSI47
Ceiling grid	Module size: modules 600 x 600, 300 x 1200 Exposed tee, concealed tee, and plasterboard ceilings
Light source	Fluorescent: 2 x MASTER TL-D / G13 / 36 W (rectangular version) 4 x MASTER TL-D / G13 / 18 W (square version)
Lamp included	No
Gear	Electronic, 220 - 240 V / 50 - 60 Hz: - Electronic Ballast Primalume (EBP) - Electronic Ballast Transalume (EBT) Electro magnetic, 220 V, 230 V or 240 V / 50 Hz: - Inductive (I) - Parallel compensated (IC)
Optic	High-gloss optic, parabolic louvers (C5) High-gloss mirror, faceted (C3) Matt mirror, ribbed cross louvers (M2)
Optical cover	Prismatic cover (P) Opal cover (O)
Connection	Screw connection
Option	Available on request: - Emergency lighting, 3 hours - Gear: High Frequency Performer or Regulator - Connection: Wieland
Material	Housing: post-painted steel, white RAL9010 Optic: anodized aluminum Optical cover: PET
Installation	Individual; lay-in exposed ceiling grid or with ceiling brackets in concealed ceiling grids or plasterboard ceilings
Accessory	Bracket ZBSI47 SMB SET40 for concealed ceiling (40 pcs suitable to install 10 luminaires)
Main applications	Office, recreation, retail

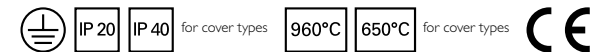



TBSI47 recessed luminaire with TL-D fluorescent lamps and a high-gloss high-quality aluminum optic with parabolic lamellae (C5)

**Preferred selection**

Product ID	Order Code
TBSI47 4xTL-D18W IC 230V-50Hz C5	9131 010 933 xx
TBSI47 4xTL-D18W IC 240V-50Hz C5	9131 010 935 xx
TBSI47 4xTL-D18W EBP C5	9131 011 056 xx
TBSI47 2xTL-D36W IC 230V-50Hz C5	9131 010 938 xx
TBSI47 2xTL-D36W EBP C5	9131 011 059 xx

Please contact your local Philips representative for additional configurations



TBSI47 recessed luminaire with TL-D fluorescent lamps and a matt high-quality aluminum optic with profiled lamellae (M2)

**Preferred selection**

Product ID	Order Code
TBSI47 4xTL-D18W IC 230V-50Hz M2	9131 010 911 xx
TBSI47 4xTL-D18W IC 240V-50Hz M2	9131 010 913 xx
TBSI47 4xTL-D18W EBP M2	9131 010 993 xx
TBSI47 2xTL-D36W IC 230V-50Hz M2	9131 010 916 xx
TBSI47 2xTL-D36W EBP M2	9131 010 996 xx
TBSI47 4xTL-D18W IC 230V-50Hz C3	9131 010 922 xx
TBSI47 4xTL-D18W EBP C3	9131 010 999 xx
TBSI47 2xTL-D36W IC 230V-50Hz C3	9131 010 927 xx
TBSI47 2xTL-D36W IC 240V-50Hz C3	9131 010 929 xx
TBSI47 2xTL-D36W EBP C3	9131 011 053 xx

Please contact your local Philips representative for additional configurations



TBSI47 recessed luminaire with TL-D fluorescent lamps and a prismatic cover (P)

**Preferred selection**

Product ID	Order Code
TBSI47 4xTL-D18W IC 230V-50Hz P	9131 010 944 xx
TBSI47 4xTL-D18W IC 240V-50Hz P	9131 010 946 xx
TBSI47 4xTL-D18W EBP P	9131 011 062 xx
TBSI47 2xTL-D36W IC 230V-50Hz P	9131 010 949 xx
TBSI47 2xTL-D36W IC 240V-50Hz P	9131 010 951 xx
TBSI47 2xTL-D36W EBP P	9131 011 065 xx
TBSI47 4xTL-D18W IC 230V-50Hz O	9131 010 955 xx
TBSI47 4xTL-D18W IC 240V-50Hz O	9131 010 957 xx
TBSI47 4xTL-D18W EBP O	9131 011 068 xx
TBSI47 2xTL-D36W IC 230V-50Hz O	9131 010 960 xx
TBSI47 2xTL-D36W IC 240V-50Hz O	9131 010 962 xx
TBSI47 2xTL-D36W EBP O	9131 011 071 xx

Please contact your local Philips representative for additional configurations

**Accessories**

Product ID	Description	Order Code
ZBSI47 SMB SET40	Mounting brackets	9131 010 965 xx





Easy to mount with spring fasteners

## Simple and effective

- Latina MBS075 is a low-height, basic downlight for compact HID lamps for shops, offices, public buildings and hotels
- It offers a highly efficient gloss aluminum reflector as well as an aesthetic design and energy-saving features
- Additional benefits include easy maintenance and easy ceiling mounting

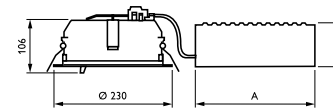

MBS075

Dimensions in mm	A	B
IC	234	84
EHS	200	58

### Latina MBS075

Type	MBS075
Light source	HID: 1 x MASTERColour CDM-TD or MHN-TD / RX7s / 70, 150 W
Lamp included	No
Lamp position	Horizontal
Gear	Electro magnetic, 230 V / 50 Hz: Electronic High frequency Standard (EHS) Electronic, 220 - 240 V / 50 - 60 Hz: Parallel compensated (IC)
Color	White
Gear box	Separate pre-wired gear box in natural aluminum included
Material	Body and reflector: aluminum Outer ring: aluminum Decorative front glass included
Installation	Cut-out diameter: 215 mm Suitable for ceiling thickness: 2-24 mm Fixation by means of spring fasteners
Main applications	Retail

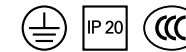

Latina MBS075 downlight with compact metal halide lamp. Pre-wired metal gear tray and decorative front glass included

### Preferred selection

Product ID	Order Code
MBS075 1xCDM-TD70W EHS WH	9114 011 41880
MBS075 1xCDM-TD70W IC WH	9114 011 42680
MBS075 1xCDM-TD150W IC WH	9114 011 42880

Please contact your local Philips representative for additional configurations



Dimensions in mm

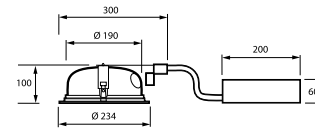

FBH020

FBH020

Type	FBH020
Light source	Compact fluorescent: 2 x MASTER PL-C 2 Pin / G24d-2 / 18 W 2 x MASTER PL-C 2 Pin / G24d-3 / 26 W 2 x MASTER PL-C 4 Pin / G24q-2 / 18 W 2 x MASTER PL-C 4 Pin / G24q-3 / 26 W
Lamp included	Yes (lamp color 840)
Lamp position	Horizontal
Gear	Electro magnetic (low loss), 230 or 240 V / 50 Hz: Inductive (I) Inductive, parallel compensated (IC) Electronic, 220 - 240 V / 50 - 60 Hz: High Frequency (HF)
Material	Body and gear box: metal Reflector: high-gloss anodized metal
Installation	Fixation by means of spring fasteners Through-wiring possible
Maintenance	Direct lamp access or after removing the front glass
Accessory	Frosted glass cover; clear decorative glass cover
Main applications	Retail, recreational, public buildings



Simple and effective

- Latina is a recessed downlight for compact fluorescent PL-C lamps, with spring fasteners for easy and quick installation
- Square and round models are available
- Latina comes in ready-to-install kit versions with pre-mounted lamps and pre-connected separate gearbox
- Accessories include a frosted glass cover and clear decorative glass cover



Frosted glass 5 pieces per box



Recessed glass, structured 5 pieces per box



Latina FBH020 downlight with compact fluorescent lamps and high-gloss optic

Preferred selection

Product ID	Weight (kg)	Order Code
FBH020 2xPL-C/2P18W/840 K I 230V LIS	3.0	180007 99
FBH020 2xPL-C/2P18W/840 K IC 230V LIS	2.8	180021 99
FBH020 2xPL-C/2P26W/840 K I 230V LIS	3.0	180014 99
FBH020 2xPL-C/2P26W/840 K IC 230V LIS	2.8	180038 99
FBH020 2xPL-C/4P18W/840 K HF 230-240V LIS	1.9	275192 99
FBH020 2xPL-C/4P26W/840 K HF 230-240V LIS	1.9	275208 99

Please contact your local Philips representative for additional configurations

Product ID	Order Code
GBH020 FRG 5pcs	180083 99

Product ID	Order Code
GBH020 RG 5pcs	180090 99

# Zadora adjustable

QBD570



## Free to create



Zadora fixed recessed (QBS570)

- Zadora is a range of recessed downlights for MASTERLine 35 and 50 mm dichroic halogen lamps (with beams of 8°, 24°, 36° and 60°) and Twistline Alu lamps
- It is available in fixed and adjustable versions, the latter offering 30° orientation from the vertical
- Maintenance is made easy by direct lamp access

# Zadora adjustable

QBD570

## Dimensions in mm

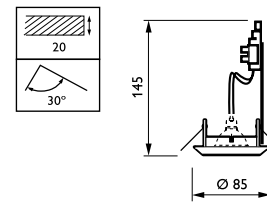

QBD570

## Zadora Adjustable

Type	QBD570
Light source	Halogen: - 1 x MASTERLine ES / GU5.3 / 45 W
Lamp beam angle	MASTERLine 25°, 40°
Lamp included	No
Lamp position	Vertical
Color	Grey (GR) White (WH) Black (BK) Anthracite (ANT) Aluminum (ALU) Matt finishing (MAT) Chrome (CR) Gold (GO)
Material	Die-cast aluminum and steel
Installation	Fixation by means of spring fasteners
Maintenance	Direct lamp access
Remarks	Bracket installed to ensure a safe distance between luminaire and ceiling
Main applications	Office, retail

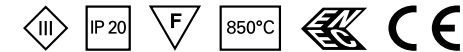

Zadora QBD570 grey      Zadora QBD570 white



Zadora QBD570 black      Zadora QBD570 anthracite



Zadora QBD570 aluminum      Zadora QBD570 matt satin



Zadora QBD570 chrome      Zadora QBD570 gold

## Preferred selection

Product ID	Weight (kg)	Order Code
QBD570 1xHAL-MR50-45W 12V BR GR LIS	0.17	180236 99
QBD570 1xHAL-MR50-45W 12V BR WH LIS	0.17	180250 99
QBD570 1xHAL-MR50-45W 12V BR BK LIS	0.17	180205 99
QBD570 1xHAL-MR50-45W 12V BR ANT LIS	0.17	180199 99
QBD570 1xHAL-MR50-45W 12V R ALU LIS	0.17	180182 99
QBD570 1xHAL-MR50-45W 12V BR MAT LIS	0.17	180243 99
QBD570 1xHAL-MR50-45W 12V BR CR LIS	0.17	180212 99
QBD570 1xHAL-MR50-45W 12V BR GO LIS	0.17	180229 99

Please contact your local Philips representative for additional configurations



## Free to create



Zadora Adjustable recessed (QBD570)

- Zadora is a range of recessed downlights for MASTERLine 35 and 50 mm dichroic halogen lamps (with beams of 8°, 24°, 36° and 60°) and Twistline Alu lamps
- It is available in fixed and adjustable versions, the latter offering 30° orientation from the vertical
- Maintenance is made easy by direct lamp access

### Dimensions in mm

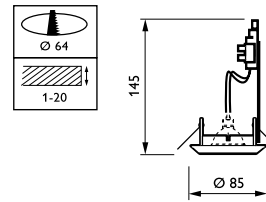

QBS570

### Zadora Fixed

Type	QBS570
Light source	Halogen: - 1 x MASTERLine ES / GU5.3 / 45 W
Lamp beam angle	MASTERLine 25°, 40°
Lamp included	No
Lamp position	Vertical
Suspension / mounting	Bracket
Color	Grey (GR) White (VWH) Black (BK) Anthracite (ANT) Aluminum (ALU) Matt finishing (MAT) Chrome (CR) Gold (GO)
Material	Die-cast aluminum and steel
Installation	Fixation by means of spring fasteners
Maintenance	Direct lamp access
Remarks	Bracket installed to ensure a safe distance between luminaire and ceiling
Main applications	Office, retail



Zadora QBS570  
grey



Zadora QBS570  
white



Zadora QBS570  
black



Zadora QBS570  
anthracite



Zadora QBS570  
aluminum



Zadora QBS570  
matt satin



Zadora QBS570  
chrome



Zadora QBS570  
gold

### Preferred selection

Product ID	Weight (kg)	Order Code
QBS570 1xHAL-MR50-45W 12V BR VWH LIS	0.14	180335 99
QBS570 1xHAL-MR50-45W 12V BR BK LIS	0.14	180281 99
QBS570 1xHAL-MR50-45W 12V BR ANT LIS	0.14	180274 99
QBS570 1xHAL-MR50-45W 12V BR ALU LIS	0.14	180267 99
QBS570 1xHAL-MR50-45W 12V BR CR LIS	0.14	180298 99
QBS570 1xHAL-MR50-45W 12V BR GO LIS	0.14	180304 99
QBS570 1xHAL-MR50-45W 12V BR GR LIS	0.14	180311 99
QBS570 1xHAL-MR50-45W 12V BR MAT LIS	0.14	180328 99

Please contact your local Philips representative for additional configurations

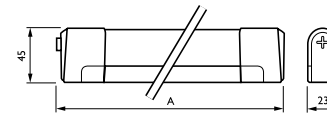

TCH128

Dimensions in mm	A
14W	623
21W	923
28W	1223

Pentura Mini	
Type	TCH128
Light source	Fluorescent: 1 x TL5-Essential 14, 21, 28 W
Lamp included	Yes (lamp color 840 or 865, 8 W version is 827)
Gear	Electronic, High Frequency (HF) - 220 - 240 V / 50 - 60 Hz - 110 - 140 V / 50 - 60 Hz.
Material	Housing and end caps: polycarbonate, white Cover: acrylic, transparent
Installation	Individual or in-line; screw mounting
Remarks	All installation accessories included; ready to install
Main applications	Home, undershelf, task lighting

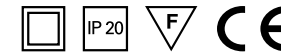

## Ultra-slim decorative batten



Individual battens can be connected to form lines of light

- Pentura Mini TCH128 is an ultra-slim decorative batten for domestic applications. A cost-effective, ready-to-install mini fluorescent solution
- Pentura Mini TCH128 offers the energy-saving benefits of miniature fluorescent lamp technology coupled with lightweight electronics and a patented internal reflector for improved lighting performance
- The batten is easy to install e.g. over worktops and workstations in the home, home office and recreational environments, etc.; it provides bright light where needed even where installation space is limited
- Pentura Mini TCH128 battens are fitted with lamp, prismatic acrylic diffuser and all fixing accessories, reducing installation time to a minimum. The battens are through-wired with removeable end-caps at both ends covering the push-button connection blocks for simple connection and through-wiring



Pentura Mini TCH128 batten

Preferred selection		
Product ID	Weight (kg)	Order Code
<b>220 - 240 V / 50 - 60 Hz versions</b>		
TCH128 1xTL5-14W/840 HF	0.36	153247 99
TCH128 1xTL5-14W/865 HF	0.36	153254 99
TCH128 1xTL5-21W/840 HF	0.43	153261 99
TCH128 1xTL5-21W/865 HF	0.43	153278 99
TCH128 1xTL5-28W/840 HF	0.50	153285 99
TCH128 1xTL5-28W/865 HF	0.50	153292 99
<b>110 - 140 V / 50 - 60 Hz versions</b>		
TCH128 1xTL5-14W/840 HF 110 - 140 V	0.36	180502 99
TCH128 1xTL5-14W/865 HF 110 - 140 V	0.36	180519 99
TCH128 1xTL5-28W/840 HF 110 - 140 V	0.50	180526 99
TCH128 1xTL5-28W/865 HF 110 - 140 V	0.50	180533 99

Please contact your local Philips representative for additional configurations



Interlinking cables

## Brighten your workload

- Pentura Mini CC TWG128 is an ultra-slim decorative batten for domestic applications. This cost-effective, ready-to-install solution offers the energy-saving benefits of miniature fluorescent lamp technology coupled with lightweight electronics and a patented internal reflector for improved lighting performance
- Pentura Mini CC TWG128 is fitted with plug-and-socket connections and an on/off switch for individual operation over worktops and workstations in the home, home office and recreational environments

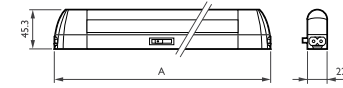

TWG128

Dimensions in mm	A
14W	605
21W	905
28W	1205

### Pentura Mini CC

Type	TWG128
Light source	Fluorescent: 1 x TL5 Essential 14, 21, 28 W
Lamp included	Yes (lamp color 840, 8 W version is 827)
Gear	Electronic, 220 - 240 V / 50 - 60 Hz: High Frequency (HF)
Material	Housing and end caps: polycarbonate, white Cover: polycarbonate, transparent
Installation	Individual or in-line; screw mounting
Remarks	All installation accessories included; ready to install
Main applications	Home, undershelf, task lighting

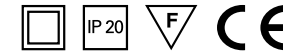

Pentura Mini CC TWG128 batten

### Preferred selection

Product ID	Weight (kg)	Order Code
TWG128 1xTL5-14W/840 HF	0.48	180120 99
TWG128 1xTL5-21W/840 HF	0.55	180137 99
TWG128 1xTL5-28W/840 HF	0.62	180144 99

Please contact your local Philips representative for additional configurations

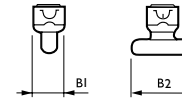
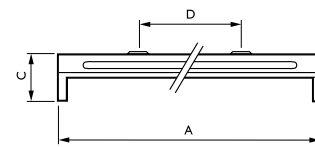

TMS012

Dimensions in mm	A	B	C	D
TMS012 1 x 18 W	614	50	78.5	515
TMS012 1 x 36 W	1224	50	78.5	820
TMS012 1 x 58 W	1524	50	78.5	820
TMS012 2 x 18 W	614	103	85.5	515
TMS012 2 x 36 W	1224	103	85.5	820
TMS012 2 x 58 W	1524	103	85.5	820

## The iconic batten

- TMS012 is a high-quality basic batten for TL-D fluorescent lamps for general lighting in industrial areas, shops and homes
- It is available with a range of reflectors and, if used with electronic gear, it saves up to 25% on energy costs
- Industrial and high-gloss reflectors and prismatic diffusers are available on request



TMS012 with EBT electronic ballast: "The energy saving batten"



TMS012 batten with GMS012 R white reflector



TMS012 batten with GMS012 P prismatic diffuser

### TMS012

Type	TMS012
Light source	Fluorescent: 1 x or 2 x MASTER TL-D / G13 / 18, 36, 5 also suitable for standard TL lamps (26 mm)
Lamp included	No
Gear	Electronic, 220 - 240 V / 50 - 60 Hz: - Electronic Ballast Transalume (EBT) Electro magnetic, 230 V or 240 V / 50 Hz: Inductive (I) Parallel compensated (IC)
Connection	Screw connection
Option	Available on request: - Other mains voltages
Material	Lacquered steel, white (0.5 mm)
Installation	Individual; screw fixing Prepared for through-wiring
Accessory	Reflector white painted steel: - Symmetrical (GMS012 R), - Asymmetrical (GMS012 RA) Reflector high gloss: - Symmetrical (GMS012 RC) Prismatic diffuser (GMS012 P)
Main applications	Industry, retail, homes, coves





TMS012 batten with 1 or 2 fluorescent lamps equipped with electronic ballast (EBT) for energy saving up to 25%

**Preferred selection**

Product ID	Order Code
TMS012 1xTL-D18W EBT	available on request
TMS012 1xTL-D36W EBT	available on request
TMS012 2xTL-D18W EBT	available on request
TMS012 2xTL-D36W EBT	available on request

Please contact your local Philips representative for additional configurations



TMS012 batten with single fluorescent lamp

**Preferred selection**

Product ID	Order Code
TMS012 1xTL-D18W   230V	9199 182 11833
TMS012 1xTL-D18W IC 230V	9199 182 11853
TMS012 1xTL-D18W   240V	9199 182 11834
TMS012 1xTL-D18W IC 240V	9199 182 11854
TMS012 1xTL-D36W   230V	9199 182 13633
TMS012 1xTL-D36W IC 230V	9199 182 13653
TMS012 1xTL-D36W   240V	9199 182 13634
TMS012 1xTL-D36W IC 240V	9199 182 13654
TMS012 1xTL-D58W   230V	9199 182 15833
TMS012 1xTL-D58W IC 230V	9199 182 15853
TMS012 1xTL-D58W   240V	9199 182 15834
TMS012 1xTL-D58W IC 240V	9199 182 15854

Please contact your local Philips representative for additional configurations

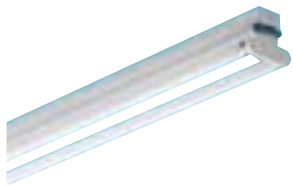

TMS012 batten with 2 fluorescent lamps

**Preferred selection**

Product ID	Order Code
TMS012 2xTL-D18W   230V	9199 182 21833
TMS012 2xTL-D18W   240V	9199 182 21834
TMS012 2xTL-D18W IC 240V	9199 182 21854
TMS012 2xTL-D36W   230V	9199 182 23633
TMS012 2xTL-D36W   240V	9199 182 23634
TMS012 2xTL-D36W IC 240V	9199 182 23654
TMS012 2xTL-D58W   230V	9199 182 25833
TMS012 2xTL-D58W   240V	9199 182 25834

Please contact your local Philips representative for additional configurations



GMS012 P prismatic diffuser for TMS012 batten, single lamp version

**Preferred selection**

Product ID	Order Code
GMS012 2 18 P	9199 186 56030
GMS012 2 36 P	9199 186 56130



GMS012 P prismatic diffuser for TMS012 batten, twin lamp version

**Preferred selection**

Product ID	Order Code
GMS012 1 18 P	9199 186 56330
GMS012 1 36 P	9199 186 56430



GMS012 R white steel reflector or GMS012 RC high gloss symmetrical reflector for TMS012 batten

**Preferred selection**

Product ID	Order Code
GMS012 1 18 R	9199 186 50030
GMS012 1 36 R	9199 186 50130
GMS012 1 58 R	9199 186 50230
GMS012 2 18 R	9199 186 50330
GMS012 2 36 R	9199 186 50430

GMS012 2 58 R	9199 186 50530
GMS012 1 18 R ALU	9199 186 55030
GMS012 1 36 R ALU	9199 186 55130
GMS012 2 18 R ALU	9199 186 55330
GMS012 2 36 R ALU	9199 186 55430



GMS012 RA white asymmetrical steel reflector for TMS012 batten

**Preferred selection**

Product ID	Order Code
GMS012 1 18 R-A	9199 186 50630
GMS012 1 36 R-A	9199 186 50730
GMS012 1 58 R-A	9199 186 50830

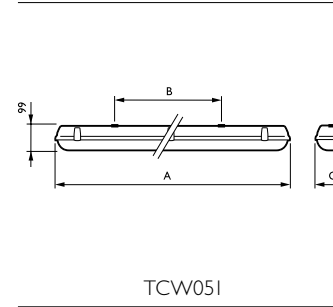

Dimensions in mm	A	B	C
TCW05 I 1x18W	665	400	84
TCW05 I 1x36W	1275	800	84
TCW05 I 2x18W	665	400	134
TCW05 I 2x36W	1275	800	134
TCW05 I 2x58W	1575	1100	134

TCW05 I	
Type	TCW05 I
Light source	Fluorescent: 1 x or 2 x MASTER TL-D / G13 / 18 W, 36 W, 58 W (2 lamps only)
Lamp included	No
Gear	Electronic, 220 - 240 V / 50 - 60 Hz: Electronic Ballast Primalume (EBP) Electro-magnetic, 220 V, 230 V or 240 V / 50 Hz: Inductive (I) Parallel compensated (IC)
Connection	Screw connection
Option	Available on request: Emergency lighting, 3 hours Other gear types MASTER TL5 / G5 lamps
Material	Housing: Polycarbonate (1 x 36 W, 2 x 36 W, 2 x 58 W) Fibre-glass reinforced polyester (1 x 18 W, 2 x 18 W) Cover: Polycarbonate
Installation	Fixation clips: stainless-steel (LOC-SS) or polyamide (LOC-PL) Individual; screw to ceiling or clicking the luminaire into pre-screwed stainless-steel ceiling brackets (using ZCW05 I MB)
Accessory	Clip-in ceiling bracket for single (MB-S) or twin (MB-T) lamp version
Main applications	Industry, under-canopy lighting

## Robust and reliable

- TCW05 I is a high-quality shock- and vandal-proof waterproof luminaire for TL-D fluorescent lamps featuring IP65 ingress protection
- Energy consumption can be reduced by 25% if electronic gear is used



Easy-to-open hingeable polyamide clip



Vandal proof stainless steel clip



Stainless steel ceiling mounting brackets. Set of 20 pieces to mount 10 luminaires

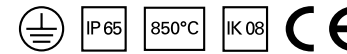

TCW05 I shock-, vandal- and waterproof luminaire for TL-D fluorescent lamps

### Preferred selection

Product ID	Order Code
TCW05 I 1xTL-D18W EBP LOC-PL	9131 010 276 xx
TCW05 I 1xTL-D36W EBP LOC-PL	9131 010 277 xx
TCW05 I 2xTL-D18W EBP LOC-PL	9131 010 278 xx
TCW05 I 2xTL-D36W EBP LOC-PL	9131 010 279 xx
TCW05 I 1xTL-D18W IC 230V-50Hz LOC-PL	9131 010 204 xx
TCW05 I 1xTL-D36W IC 230V-50Hz LOC-PL	9131 010 205 xx
TCW05 I 2xTL-D18W IC 230V-50Hz LOC-PL	9131 010 206 xx
TCW05 I 2xTL-D36W IC 230V-50Hz LOC-PL	9131 010 207 xx
TCW05 I 2xTL-D58W IC 230V-50Hz LOC-PL	9131 010 208 xx
TCW05 I 1xTL-D18W EBP LOC-SS	9131 010 280 xx
TCW05 I 1xTL-D36W EBP LOC-SS	9131 010 281 xx
TCW05 I 2xTL-D18W EBP LOC-SS	9131 010 282 xx
TCW05 I 2xTL-D36W EBP LOC-SS	9131 010 283 xx
TCW05 I 1xTL-D18W IC 230V-50Hz LOC-SS	9131 010 228 xx
TCW05 I 1xTL-D36W IC 230V-50Hz LOC-SS	9131 010 229 xx
TCW05 I 2xTL-D18W IC 230V-50Hz LOC-SS	9131 010 230 xx
TCW05 I 2xTL-D36W IC 230V-50Hz LOC-SS	9131 010 231 xx
TCW05 I 2xTL-D58W IC 230V-50Hz LOC-SS	9131 010 232 xx

Please contact your local Philips representative for additional configurations

### Accessories

Product ID	Order Code
ZCW05 I MB-S SET20	9131 010 400 xx
ZCW05 I MB-T SET20	9131 010 401 xx

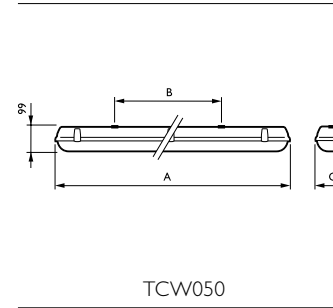

Dimensions in mm	A	B	C
TCW050 1x36W	1275	800	84
TCW050 2x18W	665	400	134
TCW050 2x36W	1275	800	134

TCW050	
Type	TCW050
Light source	Fluorescent: 2 x MASTER TL-D / G13 / 18 W 1 x or 2x MASTER TL-D / G13 / 36 W
Lamp included	No
Gear	Electronic, 220 - 240 V / 50 - 60 Hz: - Electronic Ballast Transalume (EBT) Electro-magnetic, 220 V, 230 V or 240 V / 50 Hz: - Inductive (I) - Parallel compensated (IC)
Connection	Screw connection
Option	Available on request: - Other lamp wattages (1x18 W, 1x58 W, 2x58 W)
Material	Housing: Polystyrene (1x36 W, 2x36 W) Fibre-glass reinforced polyester (1x18 W, 2x18 W) Cover: Polystyrene Fixation clips: Polyamide
Installation	Individual; screw to ceiling or clicking the luminaire into pre-screwed stainless-steel ceiling brackets (using ZCW051 MB)
Accessory	Clip-in ceiling bracket for single (MB-S) or twin (MB-T) lamp version
Main applications	Industry, under-canopy lighting

## The eco-waterproof luminaire

- TCW050 is an economy waterproof luminaire for TL-D fluorescent lamps that features IP65 ingress protection and offers trouble-free operation
- It can be opened easily, allowing quick lamp maintenance and energy consumption can be reduced by 25% if electronic gear is used



Easy-to-open hingeable polyamide clips



Stainless steel ceiling mounting brackets. Set of 20 pieces to mount 10 luminaires

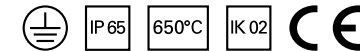

TCW050 economy waterproof luminaire for TL-D fluorescent lamps

Preferred selection	
Product ID	Order Code
TCW050 2xTL-D18W EBT	9131 010 024 xx
TCW050 1xTL-D36W EBT	9131 010 025 xx
TCW050 2xTL-D36W EBT	9131 010 023 xx
TCW050 2xTL-D18W IC 230V-50Hz	9131 010 003 xx
TCW050 1xTL-D36W IC 230V-50Hz	9131 010 004 xx
TCW050 2xTL-D36W IC 230V-50Hz	9131 010 005 xx
TCW050 2xTL-D18W I 230V-50Hz	9131 010 006 xx
TCW050 1xTL-D36W I 230V-50Hz	9131 010 007 xx
TCW050 2xTL-D36W I 230V-50Hz	9131 010 008 xx

Please contact local Philips representative for additional configurations

Accessories		
Product ID	Description	Order Code
ZCW051 MB-S SET20	Ceiling bracket for 1-lamp version	9131 010 400 xx
ZCW051 MB-T SET20	Ceiling bracket for 2-lamp version	9131 010 401 xx



## Compact and elegant

- Tempo is a range of versatile and affordable multipurpose floodlights, specially created to deliver the highest levels of lighting efficiency and reliability. They are both compact (integrated gear unit) and elegant (trendy grey metallic powder-coating (RAL 9007))
- Complete range for multiple applications
- The all-weather construction (IP65) ensures simple cleaning and speedy servicing. With a wide choice of lamp types and symmetric and asymmetric reflectors, it is ideally suited to a variety of outdoor applications, varying from façade to billboard and area lighting
- Impact-resistant die-cast aluminium housing and hinged toughened-glass cover with quick-release stainless steel clips. IP protection and temperature balance are assured thanks to the breather holes in the housing and gasket
- The Tempo range is suitable for both up- and down-lighting

### Dimensions in mm

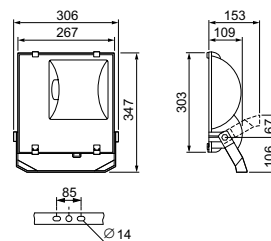

RVP 151

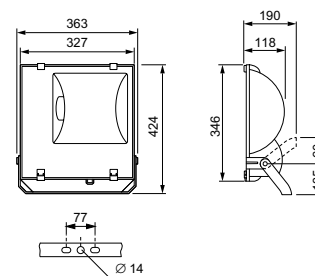

RVP 251

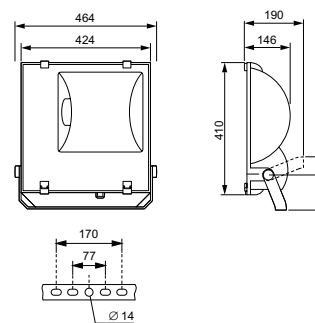

RVP 351

### RVP 151

Type	Reflector	Weight (kg)	Order code
RVP151 SON-T 70W 230V-50Hz K S LIS	Symmetric	4.5	18807200
RVP151 SON-T 70W 230V-50Hz K A LIS	Asymmetric	4.5	18808900
RVP151 MHN-TD 70W 230V-50Hz K S LIS	Symmetric	4.5	18811900
RVP151 MHN-TD 70W 230V-50Hz K A LIS	Asymmetric	4.5	18812600

### RVP 251

Type	Reflector	Weight (kg)	Order code
RVP251 MHN-TD 150W K S LIS	Symmetric	6.0	911401063380
RVP251 MHN-TD 150W K A LIS	Asymmetric	6.0	911401063280
RVP251 SON-T 150W K S LIS	Symmetric	6.0	911401063780
RVP251 SON-T 150W K A LIS	Asymmetric	6.0	911401063680

### RVP 351

Type	Reflector	Weight (kg)	Order code
RVP351 HPI-T 250W K S LIS	Symmetric	7.7	911401064180
RVP351 HPI-T 250W K A LIS	Asymmetric	7.7	911401064080
RVP351 HPI-T 400W K S LIS	Symmetric	8.8	911401064380
RVP351 HPI-T 400W K A LIS	Asymmetric	8.8	911401064280
RVP351 SON-T 250W K S LIS	Symmetric	8.6	911401064580
RVP351 SON-T 250W K A LIS	Asymmetric	8.6	911401064480
RVP351 SON-T 400W K S LIS	Symmetric	10.4	911401064780
RVP351 SON-T 400W K A LIS	Asymmetric	10.4	911401064680

All luminaires are delivered complete with lamps as a Kombi-pack (K). 230V/50Hz. Other voltages are available on request

